

Installation Guide

Version 14 | 01.26

hup! - A Building Revolution from Ultraframe

hup![®]
The better way to build

Icons



Five Times Faster to Build – Collect Cash Quicker

- 100% pre-fabrication, no cutting required on site.
- Rapid wall and roof connections.
- 10m² of wall built in minutes.
- Can be built in most weather conditions unlike brick.



Five Times More Energy Efficient - Easy Building Regulations

- Five times more energy efficient than the average UK home.
- Components compliant with Part L June 2022 Building Regulations.
- Solid roofs with U-Values less than 0.15 W/m²K for England and 0.13W/m²K in Scotland.
- Walls with a U-Value of 0.17 W/m²K, exceeding Building Regulations.



60% More Carbon Efficient

- 60% more carbon efficient to manufacture vs brick.
- Zero waste in production and on site.
- Re-use basework.
- ISO 140001 Environmental Management Accredited.
- Lower ongoing energy usage - less emissions.



Ultimate Design Flexibility – Convert More Sales

- Choose from five Ultraframe roofs.
- Compatible with any wall finishes.
- Configurable to any window and door layout.
- Perfect for extensions, conservatories, transformations, and garden homes.



Less Trades – Easy Project Management

- No bricks required – range of authentic wall finishes.
- Designed to be fitted by one conservatory team.
- Comprehensive fitting team training provided.
- Design, specify and price in one easy U-Design order.



Engineered by Ultraframe – High Quality Finish

- BBA approved Ultrapanel technology from a BBA approved factory.
- Designed to accommodate on site tolerances.
- Precision engineered for a consistent high quality finish.
- No cold bridging.

Introduction

Thank you for choosing hup!. This guide is designed to make building as straightforward as possible. Before you commence the hup! build, please take a moment to read the guide. This guide is written on the basis that a qualified surveyor has undertaken correct checks for the capability / structural performance of any existing framework / walls / foundations to verify they are fit for purpose. Any feedback - positive or negative - is welcomed so we can make our systems even better.

Contents

Tools required & Fixing summary	04	Boiler flue separation distances	20
Product components / assembly	06	Glass Roof / Hybrid Roof	21
Pre-build	07	Tiled Roof	23
General build	08	Gable End & Lean	25
Walling below an opening	10	Tiled Roof - soffit positions	26
Walling above an opening	11	Flat Roof	29
Securing walling panels	11	Wall finishings	30
Boundary Wall (Limited Access)	12	Wiring	41
Installing structural posts	14	Cable Management Panel	42
hup! on existing walls	16	Hanging objects off walls	43

For technical support, please contact the Tech Support Team on **01200 414607** or email techsupport@ultraframe.co.uk.

For everything you need to know about hup!, including guides and explainer videos, visit www.trade-hup.co.uk

Building Regulations

The hup! wall system has been assessed and pre-approved by MFA (national building inspector networks) to make Building Regulations easy.



Product

The kit is supplied with a location plan, a quality control checklist for the box in which this guide arrives and, of course, this installation guide. The location plan is used to match individual components to their respective positions.

Our numbering convention always starts at the top left, as you look from outside back at the front elevation.

Fixings Supplied



GPHS – Self Drilling Countersunk 4.2 x 38mm screw.



SLP004 – Structural Post Fixing Kit (only supplied if structural post is specified).



MTWS001 / MTWS025 – Winged Batten Screw (only supplied if battens are specified).

Fixings Not Supplied



Host wall tray to host wall example fixing: Concrete Frame Screw 7.5x70mm. Fixing choice is dependent on substrate.

Tools/Materials Required

- 300mm Width DPC
- Drill/Screwdriver
- No. 2 Square Drive (Supplied)
- No. 2 Torx Drive (for HSCCA Batten Fixings)
- 13mm Socket (for Structural Post Fixings)
- Deadblow Hammer or White Rubber Mallet
- Tape Measure
- Laser Level/Stringline
- Spirit Level
- Utility Knife
- Tin Snips
- Sealant Gun
- 15mm plasterboard



Base tray to foundation example fixing: M6 x 85mm Concrete Bolt with a minimum 1kN pull out. Fixing choice is dependent on substrate.

Health and Safety

Site safety is paramount. The Construction (Design & Management) Regulations 2015 apply to the whole construction process, on all construction projects from concept through to completion. Compliance is required to ensure construction projects are carried out in a way that secures health and safety. The installation company shall be responsible for the safety of all of the fitting team, the customer and members of the public.

The Surveyor should have carried out a risk assessment to reduce risk on site and this should have been discussed with you prior to starting.

Please use safe working platforms and ladders that comply with BS EN 131. Always use equipment in line with manufacturers recommendations. Personal Protective Equipment - such as goggles, gloves, mask and ear defenders – should be used when appropriate.

Careful consideration should be given to the safe disposal of all packaging - packaging is predominantly made from recycled materials and can be readily recycled.

Fixing table

IMPORTANT NOTES:

CUSTOMER SUPPLIED FIXINGS: The above are minimum recommended requirements and equivalent or equally approved solutions can be used.

EXTREME LOCATIONS: Some locations may require alternative specifications, to be advised by Ultraframe Ltd.

Description of joint	Substrate	Fixing Specification	Minimum required capacity per fixing	Supplied by
Ultrarroof eaves to hup! wall	NA	2no GPHS fixings internally and 2no GPHS fixings externally at maximum of 600mm cc (every clip position)	Pull out = shear = 0.6kN through 0.9mm magnelis	Ultraframe
hup! wall to host	Timber	8mm dia timber coach screw	Shear = 2.3kN	Customer
	Brick/Block/Concrete	Concrete Frame Screws 7.5x70mm staggered 300mm vertically e.g.TIMco	Shear = 2.3kN	Customer
hup! structural post to foundation	hup! base	4no.M8 Anchor BOLTS (SLP004) into concrete pad	Pullout = 5.6kN	Ultraframe
	Concrete	4no.M8 Anchor BOLTS (SLP004)	Pullout = 5.6kN	Ultraframe
	Quickbase	Please contact techsupport@ultraframe.co.uk for more details		
hup! wall base tray to foundation	hup! base	As per hup! Base specification e.g. 2no 10mm diax19mm hex head at max 600mm cc	Pull out = 1kN @ 600mm cc	Customer
	Concrete	M6 x 85mm Concrete Bolt at 600mm cc e.g. FFT Concrete Bolt M6x100 Hex/Flange Head	Pull out = 1kN @ 600mm cc	Customer
	Quickbase	FFT Concrete Bolt M8x150 Hex/Flange Head	Pull out = 1kN @ 600mm cc	Customer

Product Assembly



The hup! building system is designed to be used with any of the five Ultraframe roofing systems

hup! walls, when combined with the choice of one of five different roofing systems, delivers a lightweight yet robust structural solution which can be built and made watertight in a fraction of the time it takes to build the equivalent structure using standard construction methods.

Please note: If installing brick slip rails, ensure that starter rail is fitted prior to installing battens and calcium silicate board (see p29).

Wall Panel Components



Four Roof Types



Glass Roof Hybrid Roof Tiled Roof Flat Roof



Ensure the host wall is plumb and all measurements and set out positions are taken from a plumb datum line.

Pre-build

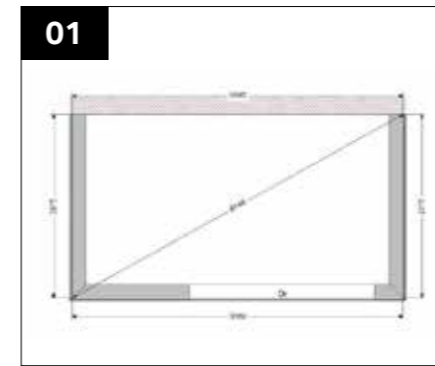

01 Ensure the basework is square and accurate by checking diagonals against provided build paperwork/location plan.



02 Where the walling panels abut the host wall a vertical DPC (NOT SUPPLIED) is required. To mark the position, strike a vertical line at the inside face of the outcourse of the foundation brickwork (or 100mm in from external base).



03 Install a vertical DPC suitable for the local environmental conditions to create a continuous cavity, 25mm cut out for the DPC is required.



04 Insert the DPC into the channel created, this will require folding into an 'L' shape, the DPC may require cutting to seat correctly. Use packers to keep the DPC in place. Once the walling panels are fitted this will then be folded again to form a 'Z' shape. If required repeat this and the previous two steps on other junctions with the existing structure.



05 Ensure base is level. If required level off with metal or slate shims or a bed of mortar.



06 Position horizontal DPC (NOT SUPPLIED, 300mm min. recommended) around the perimeter of the base aligning with the external face and lapping up the host wall. Where walls are to be positioned, the DPC should run past the base trays, by minimum of 50mm, allowing for it to be lapped up the aperture face of walling.



07 Referring to the location plan, loosely position the base trays on top of the DPC. Where walls are to be positioned, the DPC should run past the base trays, by minimum of 50mm, allowing for it to be lapped up the aperture face of walling.



08 The host wall tray can be used to strike a plumb datum line down from the host wall. This can then be used to find the correct position for the base trays.

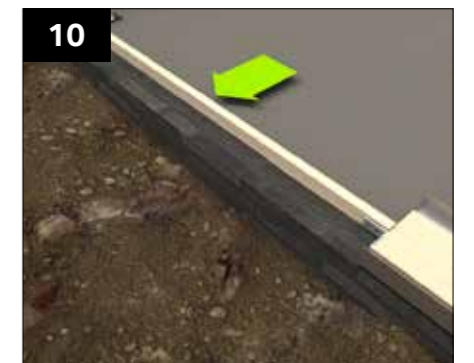

10 These trays can then be temporarily joined together using the provided set out battens and the tray steels as a datum, this step is optional primarily to assist with accurate tray positioning. Refer to your base plan for set out sizes

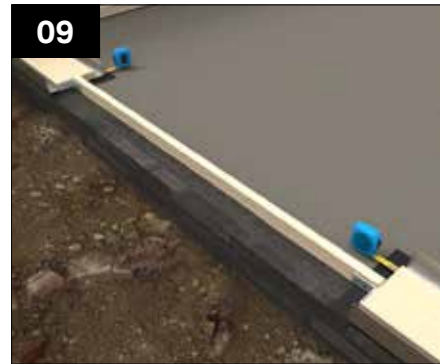

Perform dimensional checks to ensure the trays are positioned precisely.



Through the punched holes in the base trays pre-drill the foundations using appropriate size drill bit for fixings (not supplied). Example fixing: M6 x 85mm Concrete Bolt with a 1kN pull out @ 600mm max centres or similar suitable approved for the substrate. Refer to fixing table at start of guide.

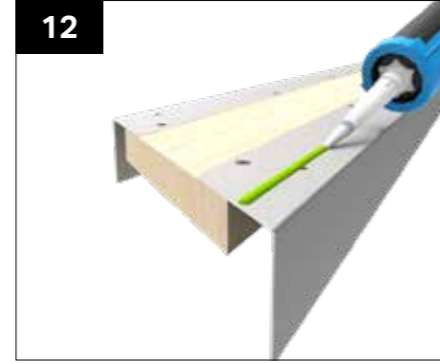

Once satisfied with the tray positioning run two beads of low modulus neutral cure sealant on the underside of each base tray and press it onto the DPC in its final location.



Fix the trays down to the basework using appropriate fixings (NOT SUPPLIED) through pre punched holes. M6 x 85mm Concrete Bolt with a 1kN pull out @ 600mm max centres or similar suitable approved for the substrate. Refer to fixing table at start of guide.

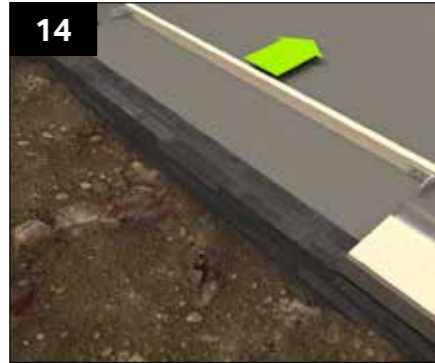

The setting out battens can now be removed, these should be set aside for use again later.

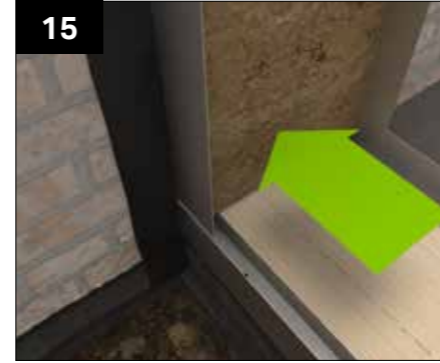

At the host wall, locate the host wall tray in position onto the base trays below. Ensure the vertical DPC is trapped in position and extends beyond the tray steel, the extra DPC will be folded over later.



Ensuring the host wall tray is plumb and level secure it into the host wall using appropriate fixings (NOT SUPPLIED). Example fixing: Concrete Frame Screw 7.5x70mm this may require pre-drilling at staggered 300mm centres or other similar approved fixing for the substrate, avoiding mortar joints. Refer to fixing table at start of guide.

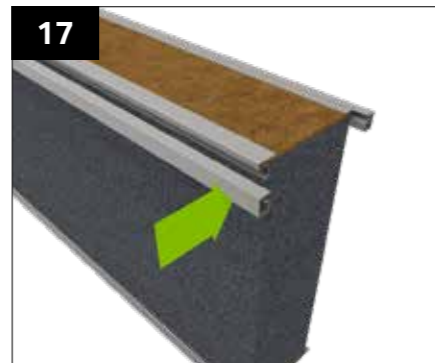

Attach the half clips to the host wall side of the panels that abut the host wall. If cable management panels have been specified, ensure that the conduit is facing internally and is positioned to the lower section of the panel.

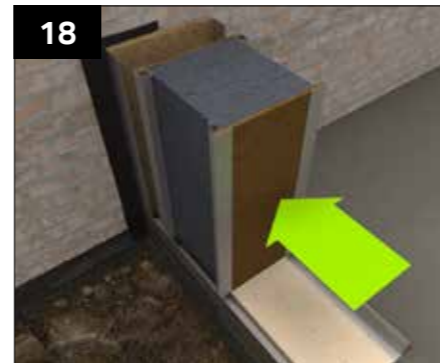

Lift the first panel into position in between the host wall/base tray steel. The half clips should run through to touch the steel angles at ground level. Refer to your panel location plan for the correct sequence.

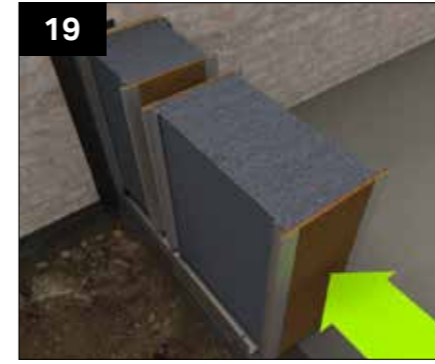

Position the following panel against the previous panel.

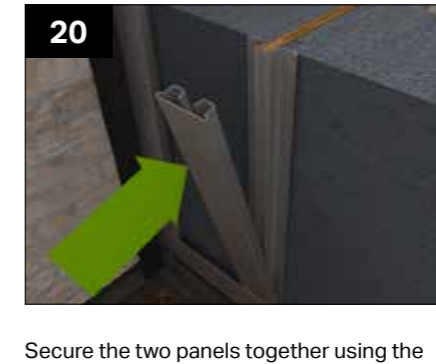

Secure the two panels together using the steel full clips. This can be done by knocking the clips onto the panel, it is helpful for a second person to brace the opposing side whilst this is being done. **PLEASE NOTE:- for Tiled Roof & Flat Roof the clips will extend beyond the tops of the walling panels and internal and external clips will differ in length.**



The previous two steps can then be repeated for the remainder of the standard walling panels.

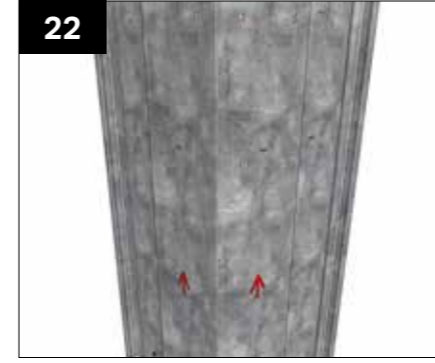

If cable management has been specified, the hup corner has an integrated insulated cable channel. The corner must be installed with the arrows pointing upwards.

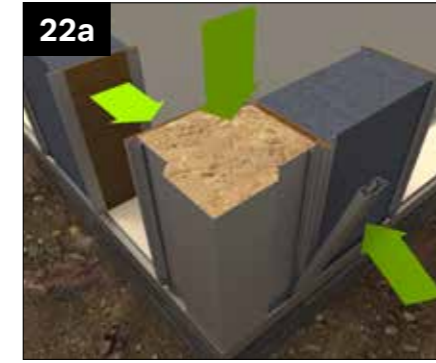

Walling corners are installed using the same methodology as the walling panels. The corners are lifted into position on the base trays at the corner. These can then be joined to the walls abutting using full clips.

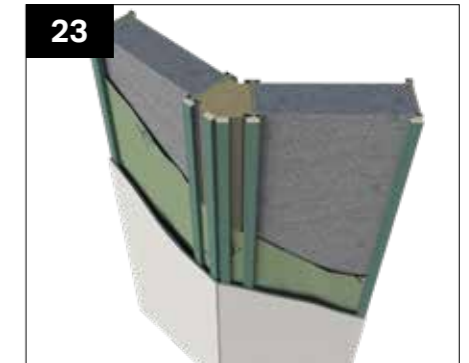

If you have specified a corner at more than 90°, you will receive a corner like that shown in the image. However, if your corner is greater than or equal to 160°, you will receive 2 less battens due to the size of the fixing face.



When an opening in the wall is reached, an aperture panel is used to terminate and allow for secure window fixing. Locate the relevant aperture panel and position this against a walling panel, as shown on the location plan.



Fit the walling panel and aperture panel together using the steel full clips, using the same method as previously used for attaching walling panels together. **Please note:- for Tiled Roof & Flat Roof the clips will extend beyond the tops of the walling panels and internal and external clips will differ in length.**

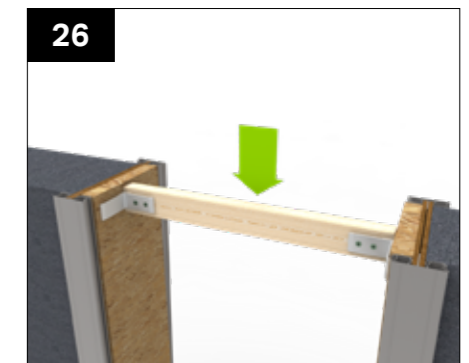

If full height openings are present the set-out battens used previously can be utilised to tie the top of the opening together, ensuring accurate set out towards the top of the wall.

Full Height Openings



Position the full row of short walling panels within the base trays next to one another.



Where the short run meets the full height walling an aperture panel will be required above each short end panel.

Walling Below an Opening

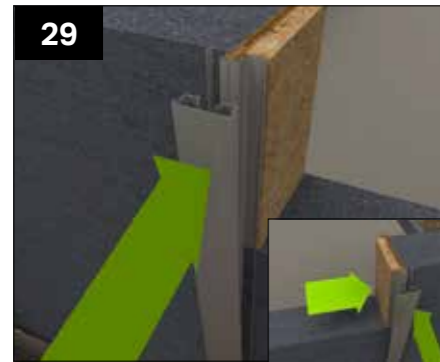

A full clip can then be used to secure both the short walling panel and aperture panel to the full height walling panel. This clip is fitted using the same method as previously used for attaching walling panels together. This process will need to be repeated for the other end of the opening.



The run of short walling panels can then be joined together using full clips as per the full height panels.



Once all panels are securely clipped together, the aperture tray can be lowered into position in between the aperture panels, capping off the walling panels below and allowing for frames to be securely fixed into the walling system.



The tray is to be fixed into each of the full clips below the wall with two fixings and the full clip to the side of the opening with four fixings through the pre-punched holes using the GPHS fixing provided. **Please note that indication lines are on the clip to aid with fixing location.**



Aperture panels are to be fitted in place either above short walling panels or above the base trays. Clips should finish inline with the tops of the aperture panels and not run the full length of the taller walling panels.



Lower the aperture shelf into position between the walling panels at either side of the opening and onto the aperture panels below.

Walling above an opening

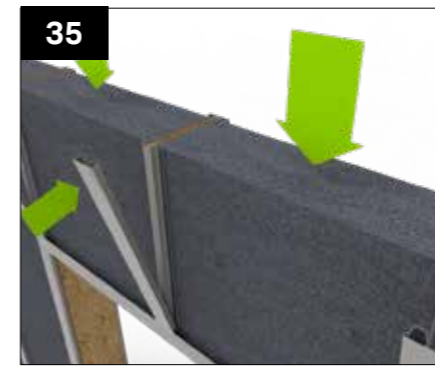

Position the walling panels into the aperture shelf and secure together using full clips. **PLEASE NOTE:- for the Tiled Roof and Flat Roof the clips will extend beyond the tops of the walling panels.**

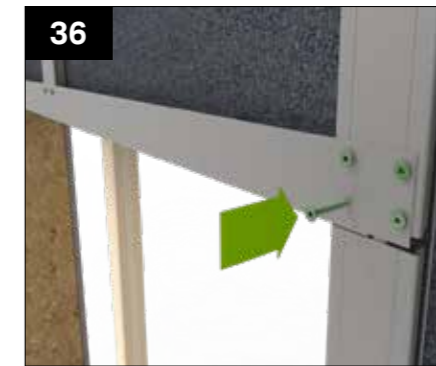

Ensuring the tray is level and propped at the centre (prop NOT SUPPLIED), fix the tray into the walling panel clips at both ends with four GPHS fixings and for each walling panels on the tray with two GPHS fixings through the pre punched holes.



Leave the prop in place, this can be removed later once the clips are secure into the beam or tray above (roof dependant).

Securing Walling Panels



Ensure that the building is plumb and level.



Secure the walling panels into the host wall tray using the GPHS fixings provided at 300mm centres.



Secure the base trays through the two pre-punched holes into each of the walling panels/clips using the GPHS fixing provided.



If a glass/hybrid roof has been specified top trays will be supplied. If a Flat Roof or UltraRoof has been specified, there will be no top tray. If the glass hybrid roof is specified with Cornice, the top tray will have a hardboard packer attached. This should sit towards the outside of the wall. Locate over the top of the wall panel aligning holes with clips.



Ensure the trays are level, now secure the walling trays in place into each panel clip through the two pre-punched holes in the tray steel and into each walling panel clips using GPHS fixing.



Securing Walling Panels

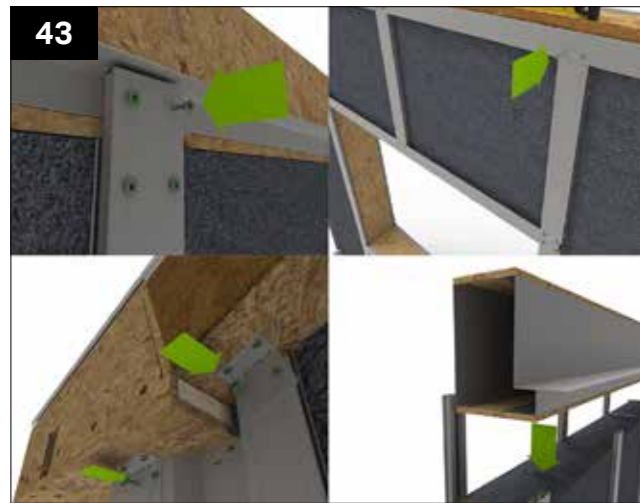

At the top of the walls (these vary with roof type), follow the relevant roof steps shown later in the guide for fixing methods.

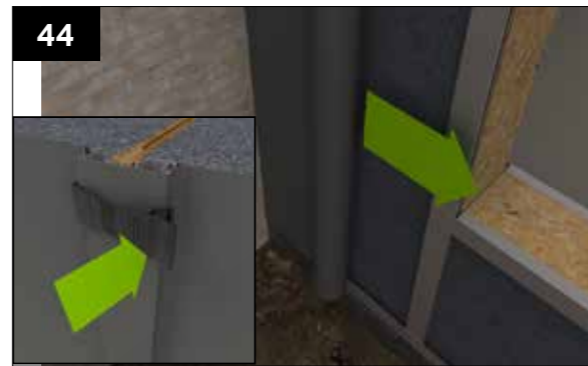

Unroll the membrane over the walls allowing this to sit slightly below DPC level (around 10 mm). Ensure that any joins in the membrane overlap by a minimum of 100mm horizontally and 150mm vertically. This can be clipped in place using the membrane clips provided. The membrane detail at the top of the wall is shown at the beginning of each roof beam installation section.

Boundary Wall (Limited Access)



Position the base tray on top of provided steel skids. Following steps up to 12 in the general installation to position the base tray, mark this position, however do not fix down to the base at this point.



At the host wall, position the host wall tray onto the base tray below. Ensure the vertical DPC (step 8) is located into the brickwork and extends beyond the tray steel, this will need to reach the wall once angled away for access.



Ensuring the host wall tray is plumb and level, using the hinged element of the host wall tray secure into the host wall. When fixing into the host wall, ensure that the fixings are positioned to the bottom of the slotted hole as shown to allow the tray to lower once the skids are removed

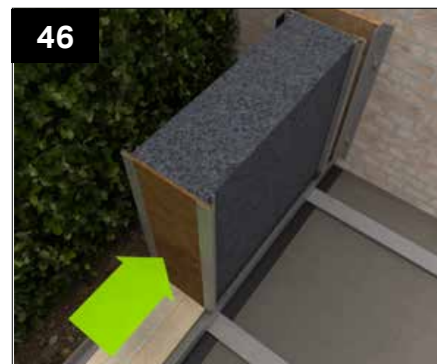

Attach half clips and position the first walling panel in place following the standard process as shown from step 21 and 22, securing the host wall tray and base trays together.



The base tray can now be angled away from the boundary by sliding on the skids to enable access. The hinged steel should bend along the perforations, whilst stabilising the wall.
If Brick Rails are being used please refer to page 29. To install the starter rail BEFORE battens and calcium silicate board.



This section of wall can then be constructed following the standard process shown from step 23, it may be advisable to fit the roof eaves beam whilst external access is available. Once the wall has been cladded externally with membrane, battens and calcium silicate board and any final wall finishing it can then be moved into its final position. See page 29 for fitting battens and calcium silicate board.

Boundary Wall (Limited Access)

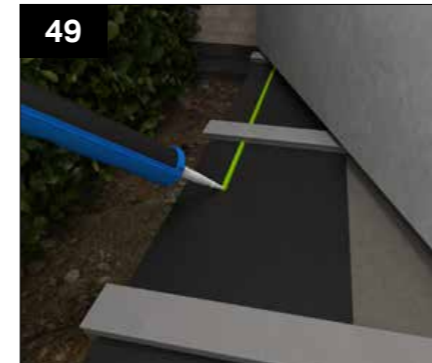

Apply sealant to both the top of the DPC where the base tray will rest and heavily seal against the host wall so that when the wall is positioned any gaps are fully sealed. Apply sealant to both base tray and host wall.

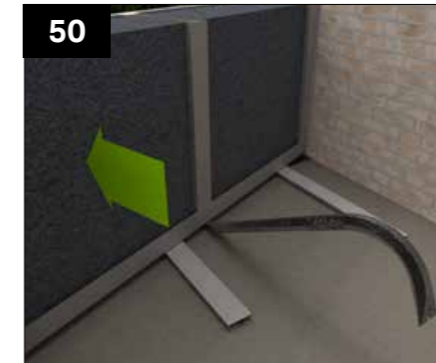

Manoeuvre the wall into its final marked position. This can be done by using a pry bar to leverage the wall into place. When using a pry bar, position this in line with the vertical wall clips to prevent distortion of the base tray.



Once the wall has been swung into position, the fixings secured into the host wall can be loosened slightly to allow the wall to drop once the skids are removed.



The skids can now be removed from below the host wall, again a pry bar can be used to take the load of the wall whilst the skids are removed (ensure lifting directly under vertical steel wall clips).



Once all skids have been removed, the host wall fixings can be retightened. If required there are additional holes in the steel angle for securely fixing into brickwork.



Finally drill through the pre punched holes and secure base tray into slab through pre punched holes as shown in step 14.

Installing structural posts (if required)



1
If a structural corner post has been specified this can be fitted after the wall has been built. Place the post at foundation level and position tight up against the corner.



2
Drill 10mm holes in the concrete footing centrally through the two large holes in SLP002 structural post. Temporarily clamp the post in place using SLP004 kit (M8 anchor bolts, washers and packers).
Note: hup! build hidden in image for clarity.

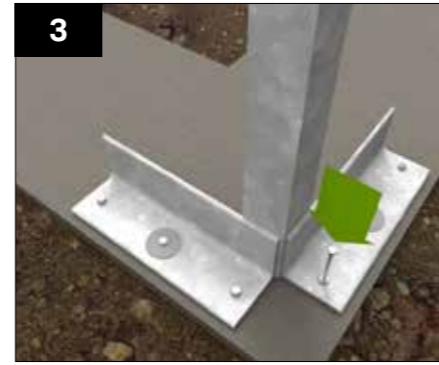

3
Ensure the post is positioned precisely then drill through the two smaller holes and secure in place using concrete anchors and washers provided in SLP004 kit.
Note: hup! build hidden in image for clarity.



4
Secure the structural post into the hup! corner using GPHS fixings through the pre-drilled holes.



5
Begin to place 2 x 25x50mm battens above the corner post and fix back using the winged screw. Maintain 12mm offset to top clip as with the rest of the battens (excluding flat roof).

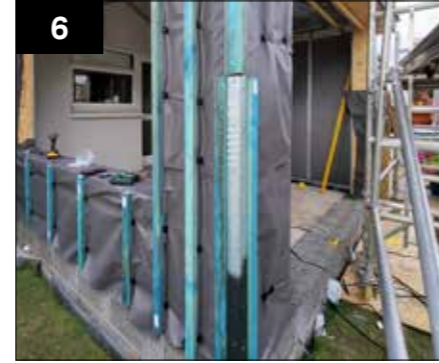

6
Fit 2 x 25x50mm battens on either side of the corner post using the winged screw.



7
After fitting the battens the L shaped steel profile can be fitted to the battens. Use GPHS fixings at 300mm centres.



8
Completed structural corner post shown, at this point the CSB can be fitted to the build.



9
Calcium silicate board starter profile and the calcium silicate board are fitted over the structural corner post as shown.

Installing structural posts (if required)

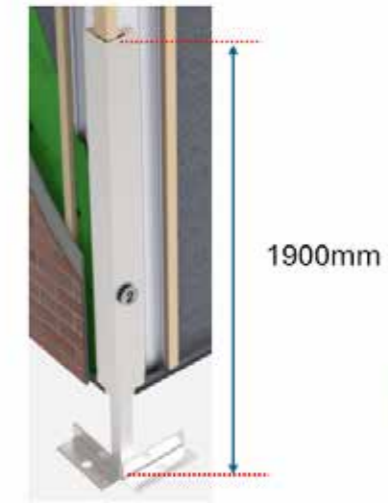
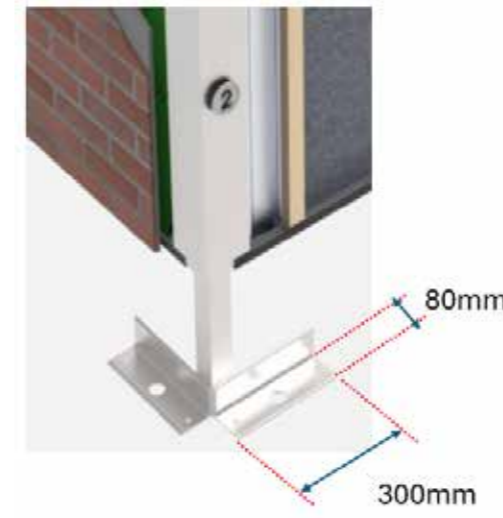

Structural post with hup! base

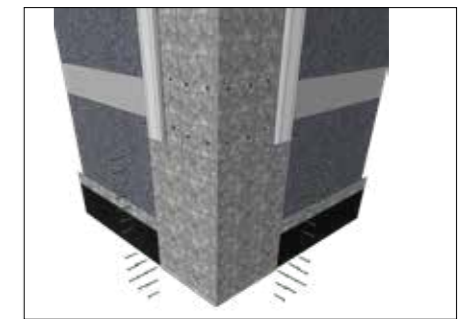
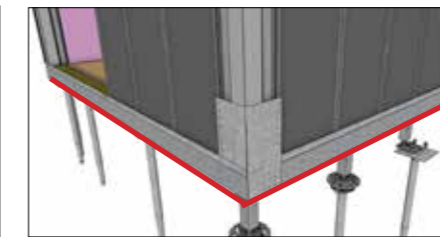
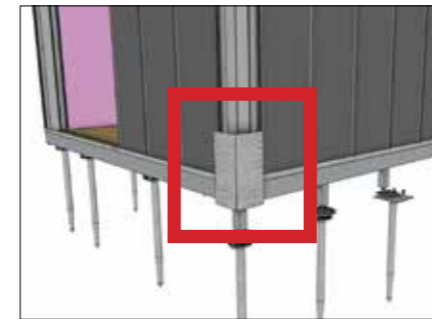

Position the structural corner bracket against the hup corner post aligning the lower edge with the underside of the base perimeter beam.

Using the provided GPHS self drilling screws, secure into both the base perimeter beam and hup corner through the pre punched holes.



hup! on existing walls



hup! on existing dwarf walls thermal upgrade requirements

If Building Regulation approval is required for the renovation the new wall in its entirety needs to meet Building Regulation thermal requirements. This means that the existing dwarf wall together with the new hup! wall combined performance should have a U-value of at least $U = 0.18 \text{ W/m}^2\text{K}$.

In almost all situations the existing wall will be significantly less than this value the following are suggested improvements are made to the existing wall.

250mm existing wall width up to 1000mm tall

Existing cavity insulation	Revised cavity insulation	Internal insulation
25mm PIR		60mm PIR
25mm Rockwool		75mm PIR
Empty	50mm EPS beads	75mm PIR

300mm existing wall width up to 1000mm tall

Existing cavity insulation	Revised cavity insulation	Internal insulation
50mm PIR		50mm PIR
60mm Rockwool		60mm PIR
Empty	100mm EPS beads	40mm PIR
50mm PIR	50mm PIR & 50mm EPS beads	30mm PIR
60mm Rockwool	60mm rockwool & 40mm EPS beads	40mm PIR

Please not fixings or straps are not supplied by Ultraframe

Materials required not supplied by Ultraframe

- Galvanised wall straps - 30mm wide by 2.5mm and 1 m long
- 95mm x 44mm treated timber
- Damp Proof Course

Fixings – not supplied by Ultraframe

- Hardened nails 4mm diameter
- No 12 woodscrews 50mm long into plugs where fixed to masonry
- 4.2 by 38mm screws for securing the hup base tray to the wall plate

It is the responsibility of the installing company to assess the existing wall for stability. This comprises of a trial dig to establish ground conditions and depth of footing. Then to investigate the type of internal blockwork that you securing to is sufficient. Pictures must be taken and submitted to your Building Control as part of your application.

You must taken evidential pictures to show you have installed the hup! wall in-conjunction with the installation guide.



hup! on existing walls with cill

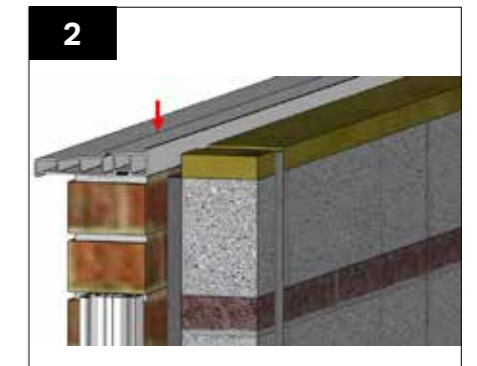
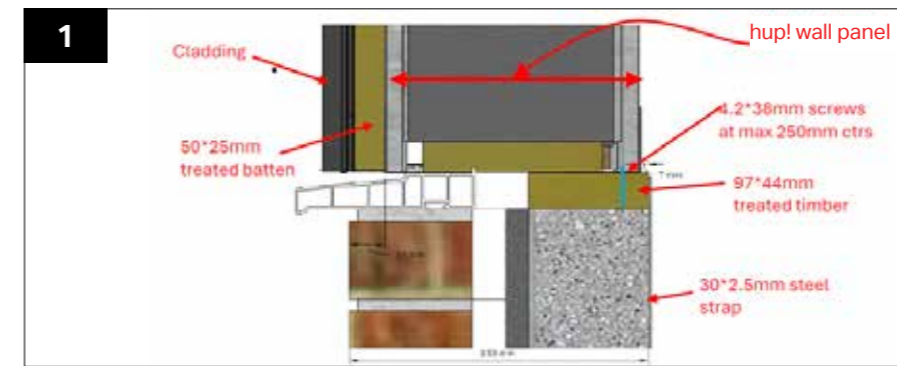

If using existing cill ensure it is secured down to the brickwork and use of a mortar bed to ensure the cill is level. Or the use of slate, or metal shims to support the cill and cement point afterwards. Do not use plastic packers.

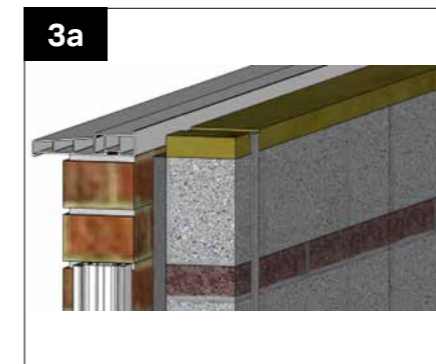

Repeat wall strapping process to the inside wall, as on page 33.

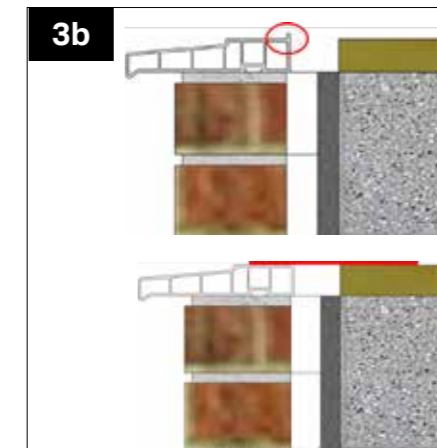

Remove upstand on the cill so to allow the cill and wall plate to be in line with each other.

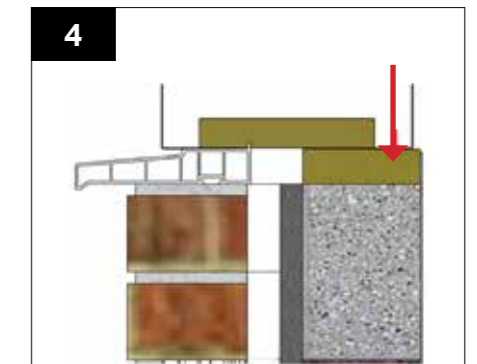

The hup! base tray is secured to the wall plate at a maximum of 250mm centres using 4.2 by 38mm screws.

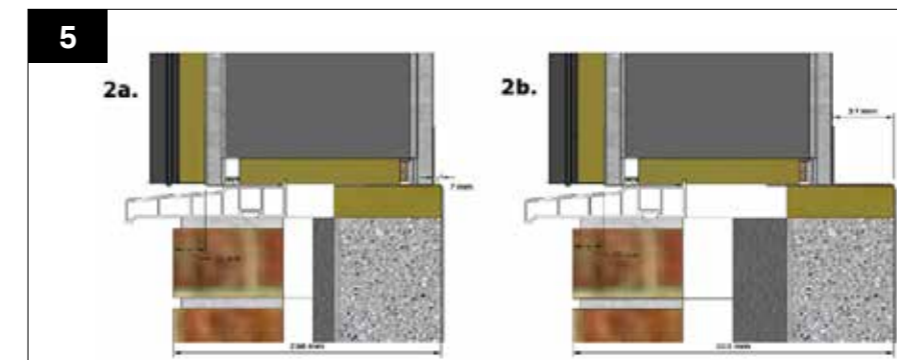

With the inside you may want to use thicker battens to make internal wall fully inline

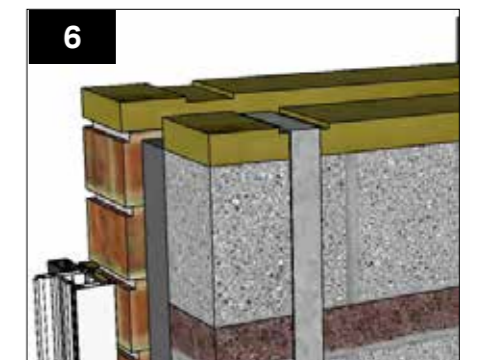

Before placing the timber wall plates (not supplied)- remove the hup! base tray into position place a DPC across the top of the wall fully closing the existing wall.

hup! on existing walls full clad



The timber is to be bedded on mortar and strapped down to the internal face of the wall. The timber is to be rebated/notched so that the wall strap sits flush into the timber. Approx. 95x44mm treated timber to be used



The Galvanised wall straps - 30mm wide by 2.5mm and 1m long (not supplied by Ultraframe).



Wall straps to be positioned 300mm from host wall / internal corners, then fixed at no more than 1500mm centres.

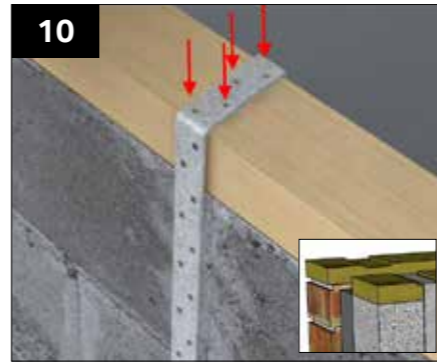
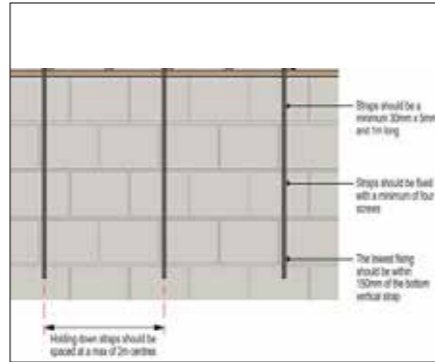

Fix through the top of the wallplate with a minimum of 2 hardened nails 4mm in diameter x 40mm, or min 2 x 4.2 x 38mm woodscrews through the top of the wall strap into the wallplate.

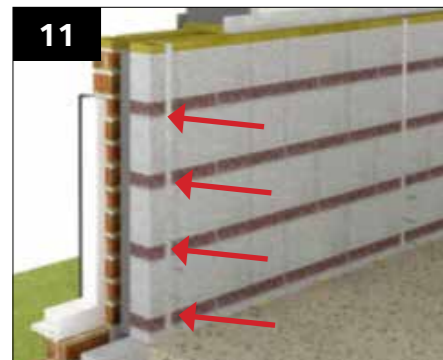

Fixed with a minimum of four hardened nails 4mm in diameter *75mm long, or No12 wood screws *50mm long into plugs (where fixed to masonry). Min 4 fixings required and with the lowest fixing secured within 150mm of the bottom of the vertical strap.



Please note where the wall is less than 600mm in height the end of the strap should be bent at 90deg and fixed to the slab). Existing floors need to be considered if staying in place for example tiled floors.

Refer back to the hup! walling installation guide for further details for completion of the hup! wall panels.

hup! on existing walls full clad

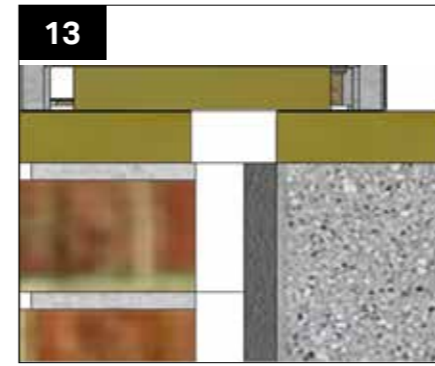

The external wall leaf also has a wallplate added, bedded on mortar to sit level with the internal wallplate. Please ensure these are level with each other.

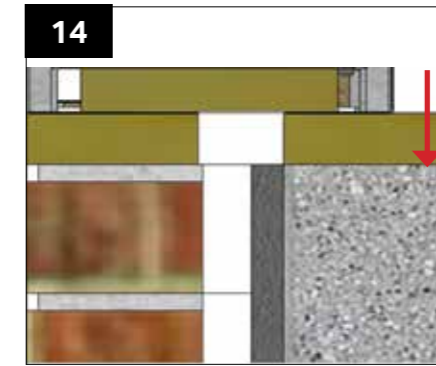

The hup! base tray is secured to the wallplate at a maximum of 250mm centres using 4.2 by 38mm screws.

Below is a sectional drawing of full clad option

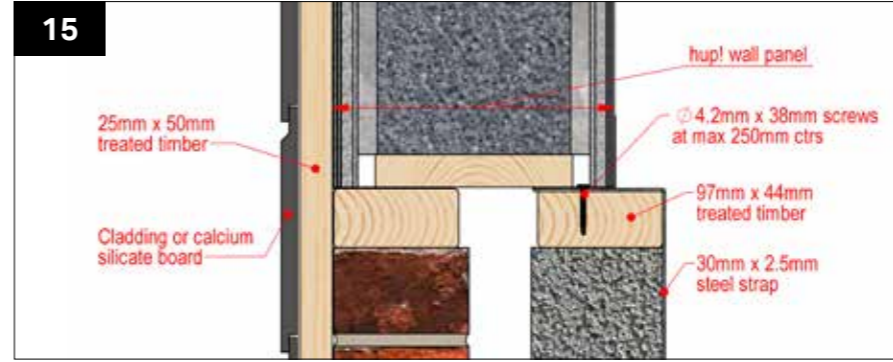

The external surface of the hup! wall steel clip is aligned with the external brick, the battens carrying the claddings then run down the clips and over the surface of the bricks such that the external finish appears as one.

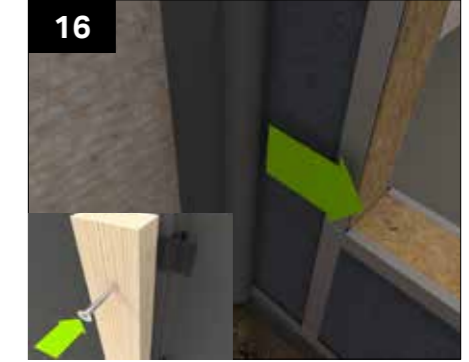

Please follow the steps within the main hup installation guide for installing the membrane and battens with the relevant roof ordered for batten positioning. Ensure the membrane overlaps onto the existing brick by min of 100mm.

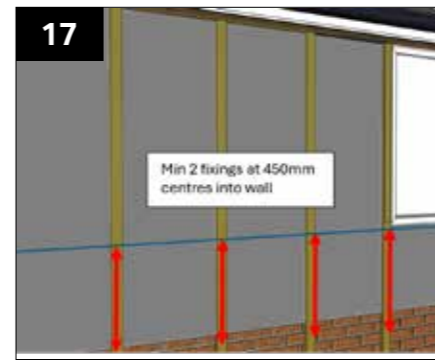

The 25*50mm treated batten running down the outer surface of the wall will be fixed to the wall at a maximum of 450mm centres using No12 screws 75mm long plugged into the wall. Now you can start to install your preferred external finish.

Boundary lines

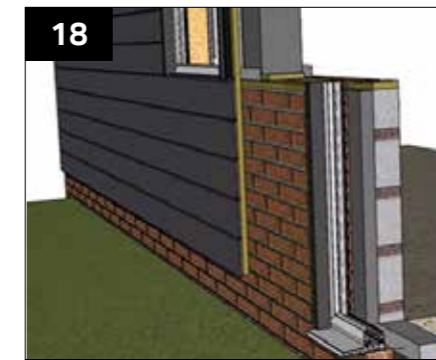

In the case where the new wall is within 1 metre of a boundary Calcium Silicate Board will be provided. This needs to be installed before battening if a cladding is being used.



A variety of claddings may be used to finish the wall please note if within 1m of a boundary 12mm weatherkern calcium silicate board must be used, and the spread of flame performance of the finish must be a minimum of B-S3 D2.

Refer back to the hup walling installation guide for further details for completion of the hup wall panels.

Boiler flue separation distances



Please note that the following are the separation distances for fan-assisted room-sealed appliances. Natural draught-balanced flues and open flues have different required dimensions.

The positioning of the flue needs to be (a minimum of):

- 300mm away from an opening window or air vent
- 25mm below guttering, drain pipes or soil pipes
- 300mm above the ground, roof or balcony level
- 2m below a Velux window
- 1,2m from an opening, such as a door or window, into the home
- 2.1m off the ground if it faces a public space such as a pavement
- If on a ground floor wall, a grill or metal box is required to cover the flue

With regards to specifications of flue extension kits or any works to the boiler that you contact a Gas Safe engineer for further advice and compliance.

Glass Roof/Hybrid Roof with cornice

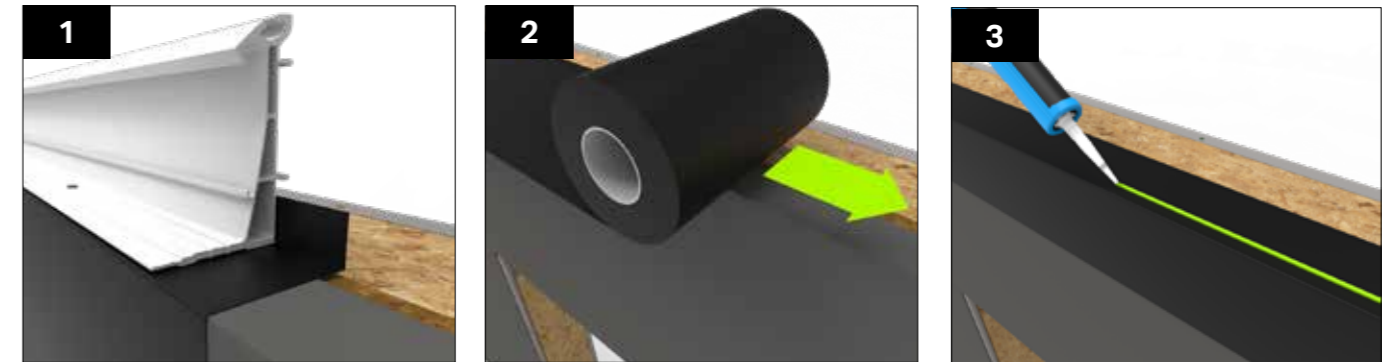

If the roof does not require a cill, the roof membrane should be folded over the top of the walling as shown above. The following steps depict the eaves beam installation.

If the roof does not require a cill, apply DPC to the top of the top tray, this will be trapped under the eaves beam and lap over the walling membrane.

Run a bead of low modulus neutral cure sealant on top of the membrane around the perimeter of the walls and frames where the eaves beam will sit.

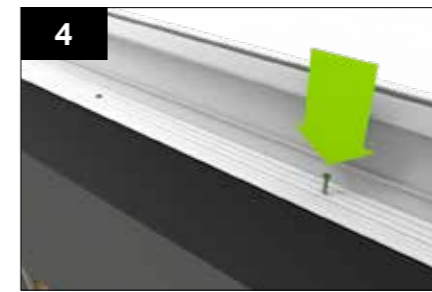

Lower the eaves into position aligning with the external wall. Secure the eaves beam down to the top tray using the GPHS provided fixing at 450mm centres and within 200mm of the eaves beam ends. Once secured, fixing heads are to be sealed with an appropriate sealant.



If the roof does require a cill: the following steps depict the eaves beam and cill installation. The walling membrane should be folded over the top of the wall and lapped up the internal face of cill as shown above.

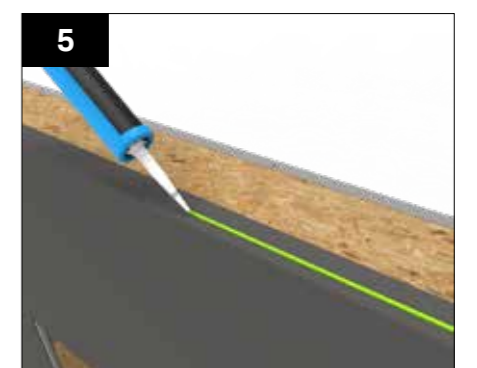

If the roof does require a cill: run a bead of low modulus neutral cure sealant across the top of the membrane over walling trays and frames.

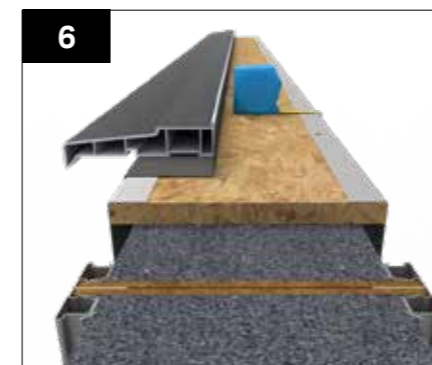

Lower the reinforced cill (not included) onto the walls. The internal face of the frames (if 70mm frames are used) is to sit 70mm inboard from the external wall steel datum (145mm from the internal). This is the outermost steel on the top tray.

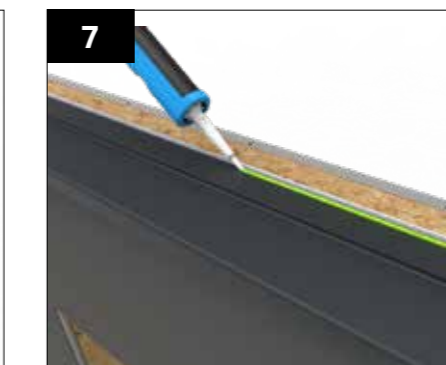

Run a bead of low modulus neutral cure sealant along the top of the cills.



Lower the eaves into position on the cill. Secure the eaves beam down through the cill and into the top tray using appropriate fixings (NOT SUPPLIED) at 450mm centres and within 200mm of the eaves beam ends. Once secured, fixing heads are to be sealed with a low modulus neutral cure sealant.

Glass Roof/Hybrid Roof

WITHOUT CORNICE



Follow the Glass Roof Guide (JN: 3773) to install the remainder of the roof. Once complete, return to this guide for external and internal finishing of the walls.



Follow the Livinroof Guide (Hybrid Roof) to install the remainder of the roof. Once complete, return to this guide for external and internal finishing of the walls.

hup!
The better way to build

hup!
The better way to build

If installing an Ultrarroof with a 72.5mm soffit, please refer to page 22 for details

Tiled Roof

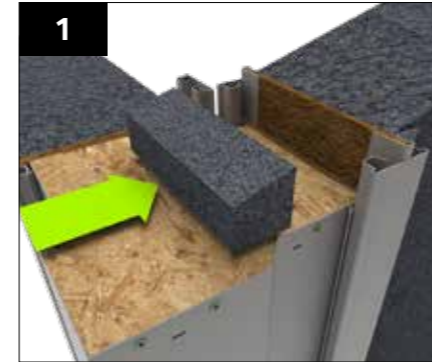

If the building has a gable end, a gable infill wedge is supplied. Apply sealant to the wedge where it makes contact with the walling corner and panel. This is to then be pushed into place as shown, once the beam is in position this wedge will be trapped.

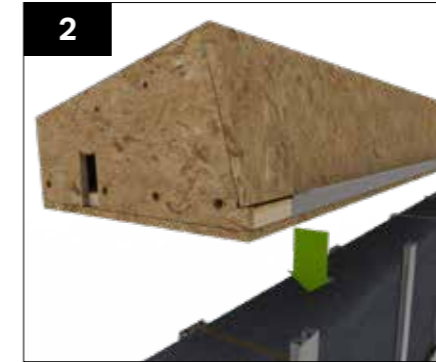

Lower the eaves beam onto the walling panels aligning the internal face of the eaves beam so that the internal walling clips are able to run through.

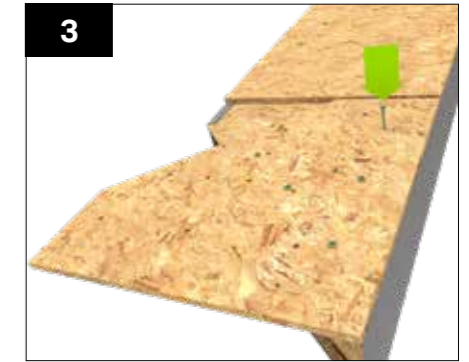

If beam returns around corner, first fix the provided OSB beam shelf to the underside of the beam using 5 of the GPHS050 screws, aligning the edge and the corner point of the OSB shelf with the edge and corner point of the beam.

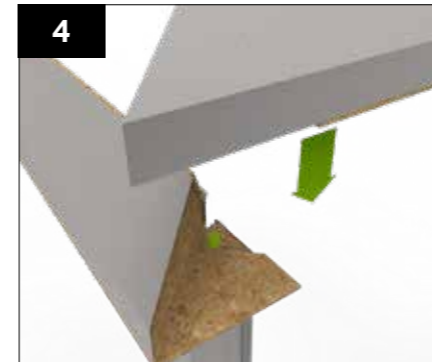

Position the beam on the corner and ensure square and level. Screw down through the OSB shelf into the top of the corner using 3 of the provided GPHS050 screws. Next fit the return beam and position correctly ensuring square and level. Screw up through the underside of the OSB shelf into the underside of the return beam using 3 GPHS050 screws.



Secure the beam in place by fixing through the internal walling clips into the beam with two GPHS fixings and into the walling panels with two GPHS fixings for every full clip.

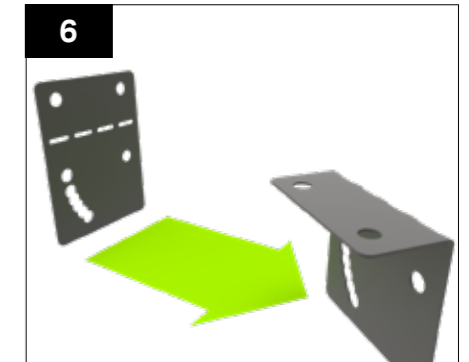

To secure the external side of the beam, bend the steel brackets to a 90° angle as shown.



Position the brackets against the walling clips and fix twice into the clips and twice into the beam above with the GPHS fixings provided.

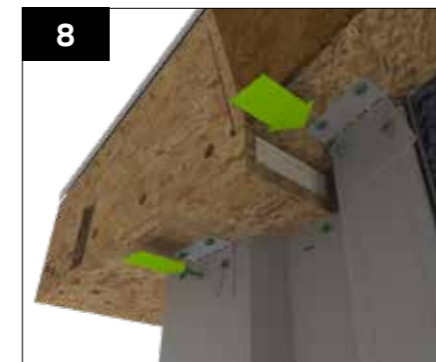

On a gable end and walling corner use these same brackets to secure the clips to the gable panel/eaves by bending to 90°, positioning it up against the underside of the beam and fixing into the clips using two GPHS fixings and into the gable panel/eaves with two GPHS fixings per full clip.



If the roof has a box gutter: The beam sitting on top of the wall is to be prefitted with the OSB cleat and lowered into position.

Tiled Roof



The beam on the box gutter side is to be lowered into position and secured in place using the angle provided. Fixed using the GPHS fixing through the pre-punched holes, three into the beam and two into full clips and a single fixing into the host wall tray.



Unroll the membrane over the walls allowing this to sit slightly below DPC level (around 10 mm). Ensure that any joins in the membrane overlap by a minimum of 100mm horizontally and 150mm vertically. This can be clipped in place using the membrane clips provided. The membrane detail at the top of the wall is shown in the following steps.



When applying the membrane ensure to lap up the underside face of the beam to ensure joints are well weathered.

Use expanding foam to fill any gaps between the walling and eaves beam.



Follow the Ultrarof Guide (Tiled Roof) for the remainder of the roof installation. Once complete return to this guide for external and internal finishing of the walls.

Gable End & Lean to

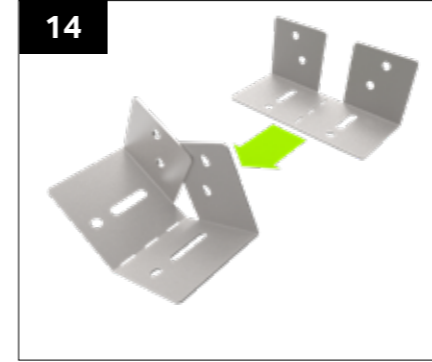

Bend provided gable ridge support bracket WPGR001 to the correct roof pitch along the perforated line.

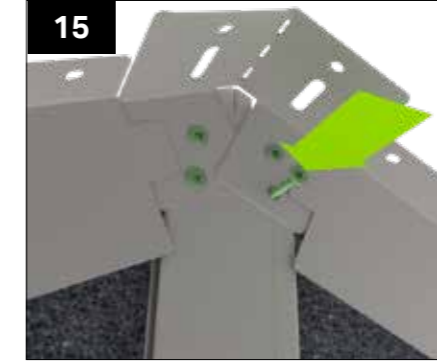

After gable wall is complete, attach the previously bent bracket to the apex of the wall and the internal angle brackets WPCA/1, aligning the upper angled faces with the top of the wall panels, using the GPHS050 screws through the pre punched holes into the vertical steel clips.



Position ridge and temporarily secure in bracket slot using the GPHS050 screws. Ensure level and walls are plumb, then tighten screw and add screws through final fix holes.



Before fitting roof gable panels, pre fit supplied steel angle bracket/s WPCA/2, aligning with the outer edge of the half clip (these could be in 2 lengths dependant on panel length). Align the upper bracket with the top edge of the gable panel and the second bracket (if required) against the first. Secure using the GPHS050 screw.

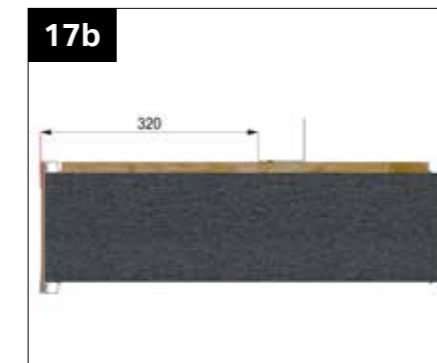

If an extended soffit has been specified, measure from the external edge of the panel by 320mm and mark a line. Align the steel angle bracket/s with this line and secure into the OSB using the GPHS050 screw.



Fit gable panels to the top of the wall panels, pushing the steel bracket against the external clips. Secure to the wall panel clips using the provided GPHS050 screws through the pre punched holes.



Secure gable panel on the inside through the previously attached angle WPCA/1, through the pre punched holes using the provided GPHS050 screws.

Tiled Roof - soffit positions



These are the options available when hup! touches the underside of the box beam.

HUP! WITH 72.5MM SOFFIT FROM EXTERNAL FRAME

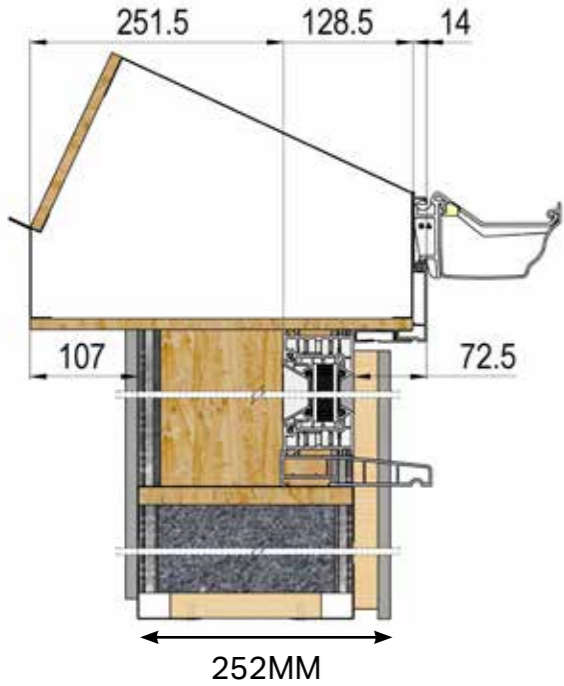

HUP! WITH 199MM SOFFIT FROM EXTERNAL FRAME

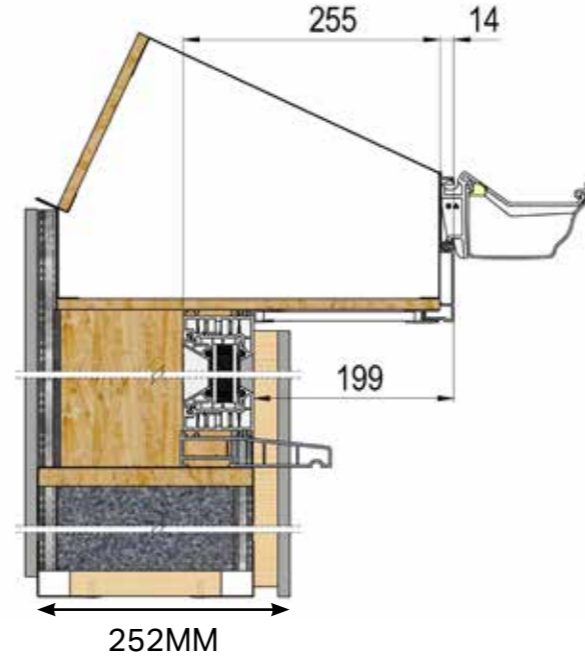

The following options are available when hup! doesn't touch the underside of the box beam and when you have dwarf walls.

HUP! ON FRAME WITH 40MM SOFFIT

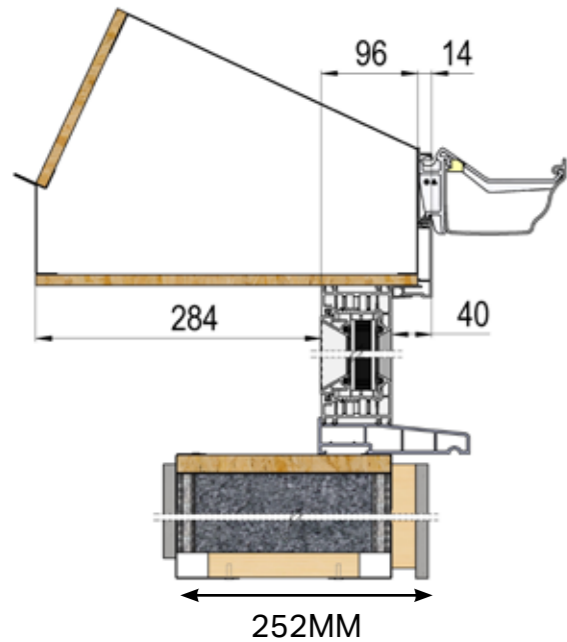

HUP! ON FRAME WITH 151.5MM SOFFIT

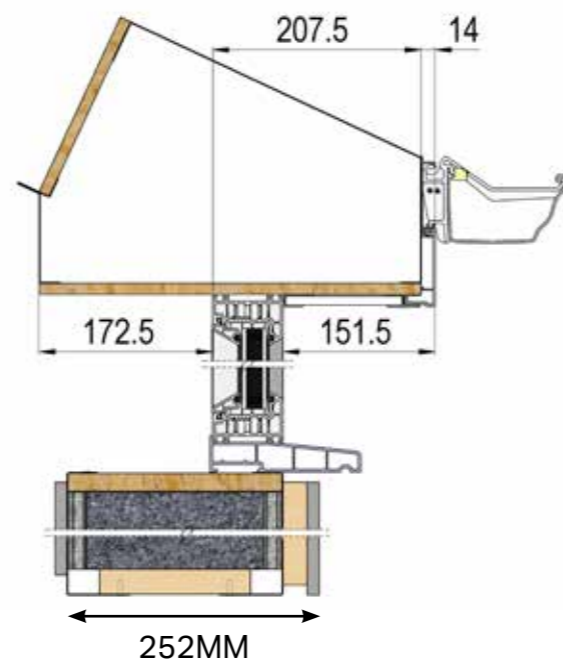

Tiled Roof - soffit positions

The following options are available when hup! doesn't touch the underside of the box beam and when you have dwarf walls.

HUP! ON FRAME WITH 72.5MM SOFFIT

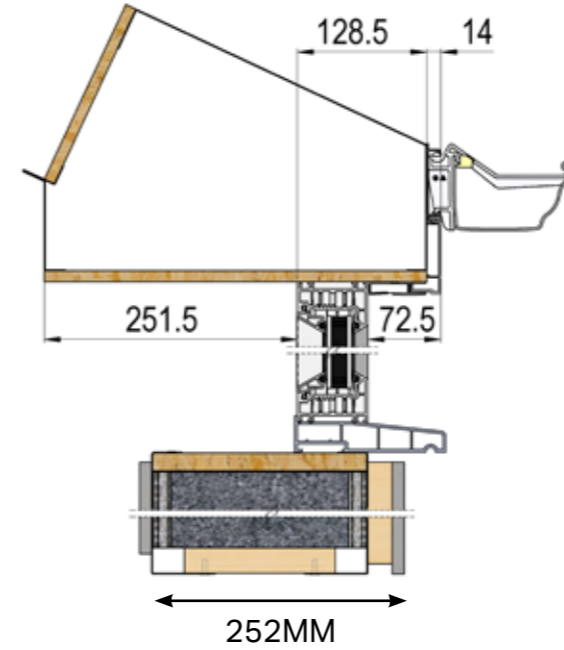

HUP! ON FRAME WITH 126.5MM SOFFIT

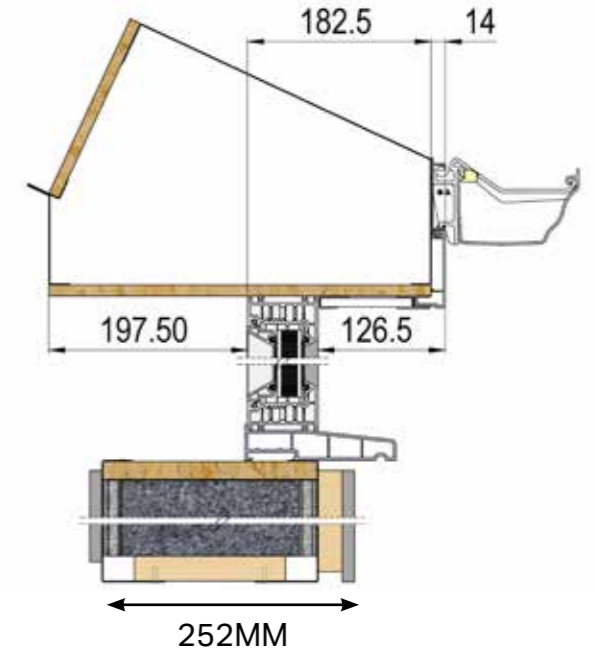

HUP! ON FRAME WITH 199MM SOFFIT

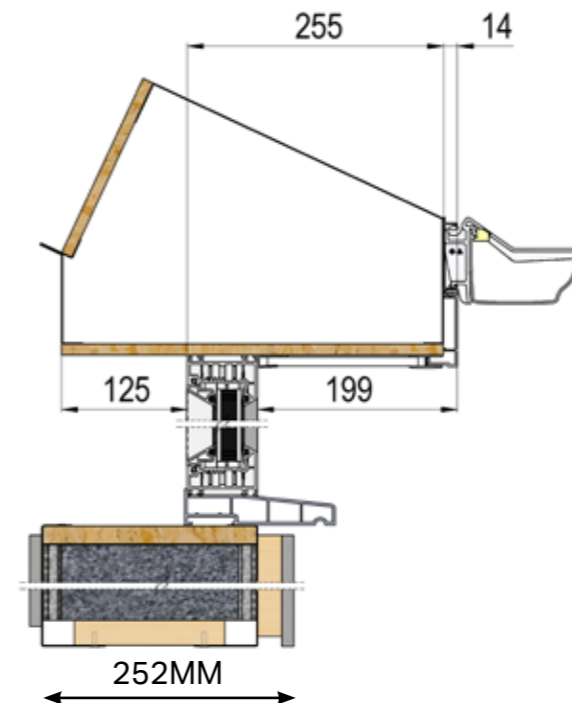

72.5mm Soffit

hup!
The better way to build

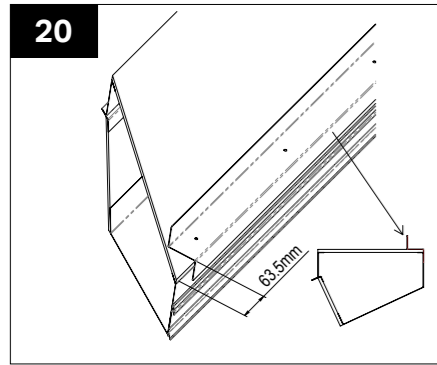

Place the M-16202 external bracket on the Ultrarof eaves beam, line up with the end of the square cut beam or 63.5mm from the mitred end

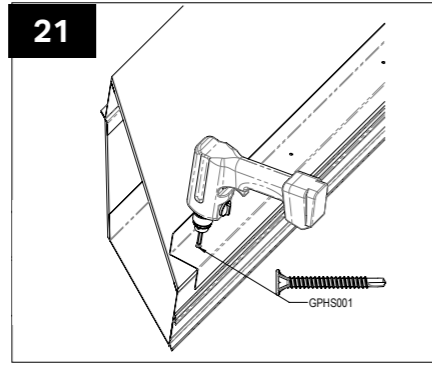

Screw the M-16202 bracket to the OSB of the Ultrarof eaves beam using GPHS001 screws into the pre punched holes.

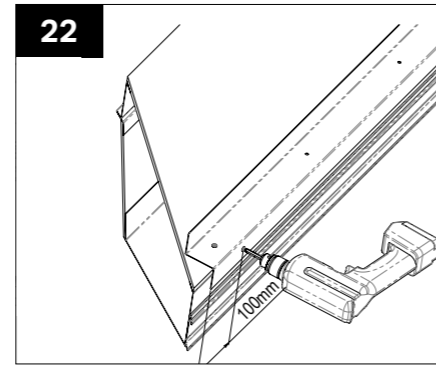

Screw the M-16202 bracket to the steel side of the Ultrarof eaves beam using GPHS001 screws 100mm from the ends and roughly 50mm offset from each existing screw.

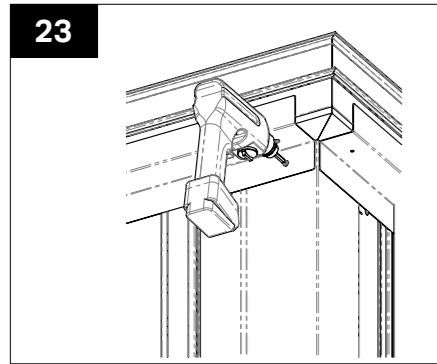

Place the beam on top the walls. then screw the M-16202 bracket to each clip and the corners

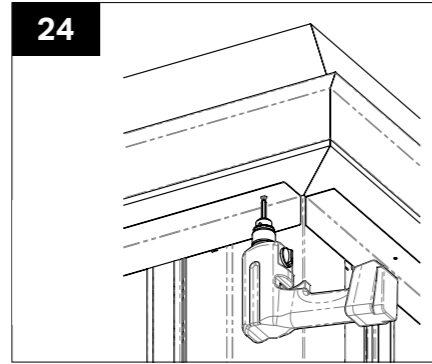

Line the M-16203 internal bracket 5mm from the corners and screw to the Ultrarof beam OSB through the holes using GPHS001 screws.

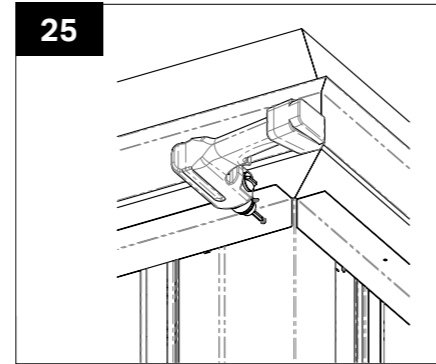

Screw the M-16203 bracket to each clip and the corners using GPHS001 screws.

hup!
The better way to build

Flat Roof

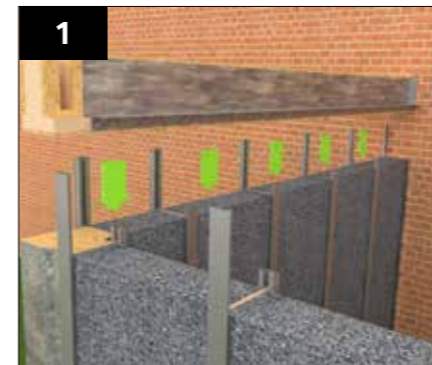

Lower the Flat Roof beam into position onto walling panels, the clips will run up both the internal and external face of the Flat Roof beam.

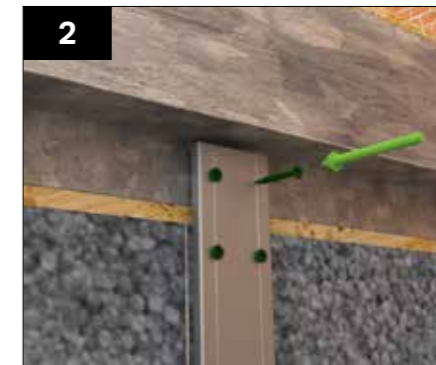

Once the beam is in position fix in place using the provided GPHS fixings into the beam with two fixings and the walling panels with two fixings for every full clip.



Externally secure each walling clip into the beam as shown using two GPHS fixings 30mm from the top and bottom of the beam and two fixings into the walling panels.



Use expanding foam to fill any gaps between the walling and eaves beam.

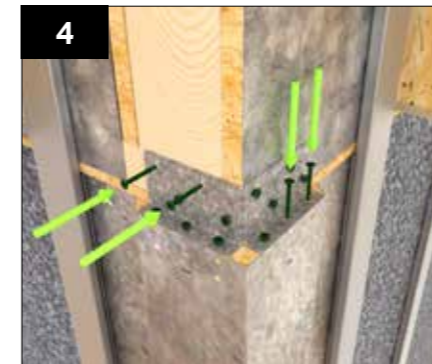

On corners, fit the clips to the beam as per the walls. Fit the 2 additional corner angle brackets WPF001 to each side as shown using GPHS050 screws.



Unroll the membrane over the walls allowing this to sit slightly below DPC level (around 10 mm). Ensure that any joints in the membrane overlap by a minimum of 100mm horizontally and 150mm vertically. This can be clipped in place using the membrane clips provided. The membrane detail at the top of the wall is shown in the following steps.

When applying the membrane this is to be folded over at the top of the clips as shown above. Refer to Flat Roof installation guide for membrane finish at roof beam dependent on fascia type.

Follow the Flat Roof installation guide for the roof construction. Once complete return to this guide for the external finishing of the walls.

Battens and Calcium Silicate Board



If glass roof fold the EPDM over the walling membrane.

Please Note: - Excluding Flat Roof, the battens on the external wall clips will be shorter than the clip length and should be set down from the underside of the eaves to allow for adequate ventilation.

The top of the batten should be positioned as outlined in table below. This differs for each roofing system.

If brick slip rails are specified, no battens or calcium silicate board are required. Skip this section and move on to "Brick Slip Rail Installation."

Roof	External Batten Position
Tiled Roof	21mm below eaves underside (includes vent trim)
Hybrid/Glass Roof with cornice	12mm below cornice
Hybrid/Glass Roof on cill	12mm below cill
Flat Roof	Standard fascia - 21mm below beam or 12mm below soffit Extended soffit - no gap required (ventilation in the soffit) Cornice - 21mm below beam or 12mm below soffit 4 tier cornice - 14mm below beam



At the host wall fold the vertical DPC over the top of the membrane prior to battening out.

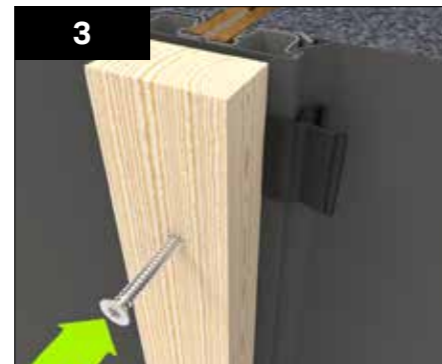

Position a 25mm batten, treated timber (optionally provided) or alternative, against the clips trapping the membrane in place. At apertures this batten is positioned inline with the opening. Secure the batten to the walling full and half clips using the winged fixing screw (provided with battens). Please Note: - Excluding flatroof, the battens will be shorter than the clip length and should be set down from the eaves level or other air flow obstructing roof elements by 12mm to allow for ventilation.

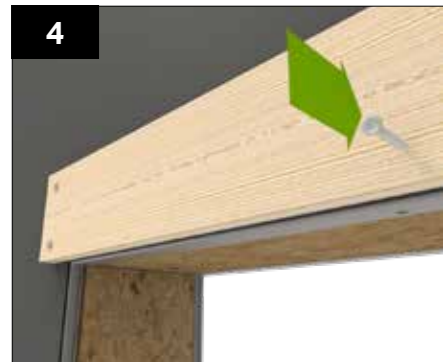

Above openings, fit a horizontal batten across the top of the opening with the base of the batten aligned with the opening in the wall.



Fit the soaker trim to the wall at a slight angle, giving it a roughly one-degree fall. The battens should terminate above and below this trim.



Using tape provided seal along the joint at the top between the soaker trim and the membrane.



Battens and Calcium Silicate Board



At corners battens should be fixed as shown. This ensures that claddings at the corners are well reinforced.

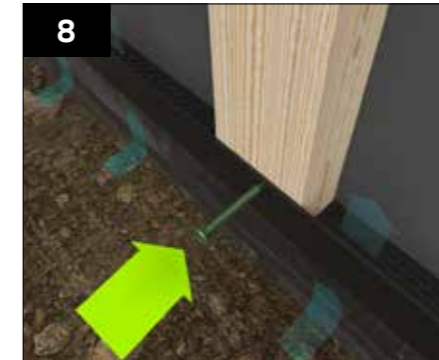

At the base of the wall attach the perforated ventilation trim to the battens. This allows for ventilation and drainage but inhibit vermin/insects. (Except for Brick Slip Rail (go to page 37), where the starter rail replaces this part)

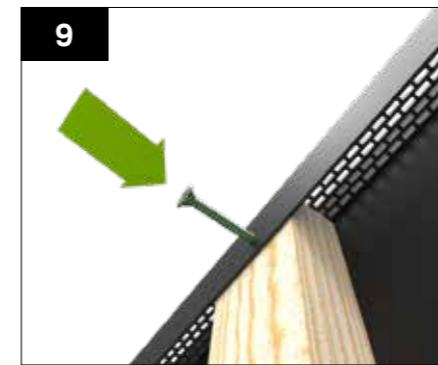

Excluding flat roof, if timber battens or claddings are used a ventilation trim is required at the top of the wall. All systems will require ventilated trim to be fitted below window if timber battens or claddings are used. A 10mm continuous gap should be left between the top of the cladding and the eaves level to allow for ventilation. The ventilation trim is to be fitted to the battens using the GPHS screw to inhibit vermin/insects.



Internally fold up the excess DPC and temporarily fix in place, this can be done with tape or other method.



Where apertures are found at ground level fold up the excess DPC and temporarily fix in place, this can be done with tape or other method.



Fit windows and doors in position. The internal face of the frames (if 70mm frames are used) is to sit 70mm inboard from the external wall steel datum (or 145mm from the internal), this is the outermost steel on the top tray.

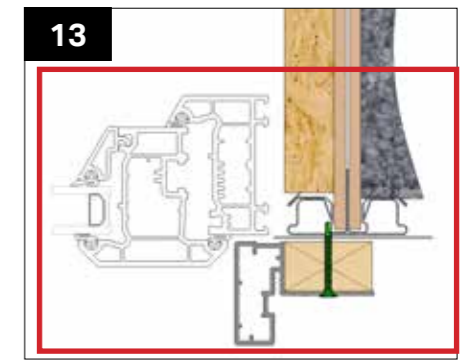

Around the perimeter of the walling openings fit the (optional) aperture trim. This will need to be cut into the cill. This is secured into the battens using GPHS.



Battens and Calcium Silicate Board



Using the DPC level on the host wall, or the bottom of the base tray, align the ower edge of the cement board starter trim WPST/1 or WPST/2. Ensure level and secure to the face of the battens through each pre punched hole using the GPHS050 screws. If using brick slips rails and within 1m of a boundary, brick slip starter will be fitted prior to battens.

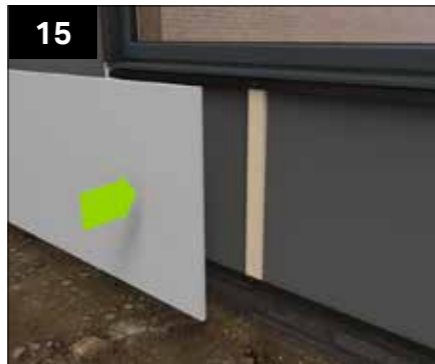

Referring to the location plan position the cement board against the battens, ventilated and aperture trims. This should sit at DPC level and if timber battens are used a 10mm continuous gap must be left at the top between the board and roof structure to allow air flow.



Mark the boards with the batten positions to ensure the fixings can be aligned and secured into the battens below.



The boards can then be secured to the walling system by screwing the GPHS fixings through the cement board into the battens. These fixings should be fixed at 150mm centres around the perimeter and at 300mm centres vertically in the centre of the board.



Brick Slips Rail Installation

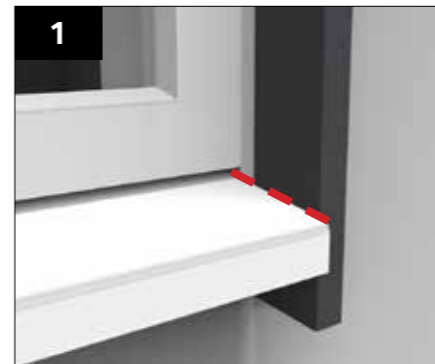

If specified install the aperture trims. The side trims are supplied oversized. Mark and cut to fit to cill, then fix in place using GPHS001 fixings at 300mm centres. The trim should overlap the frame by 20mm so that the inside face aligns with the aperture.

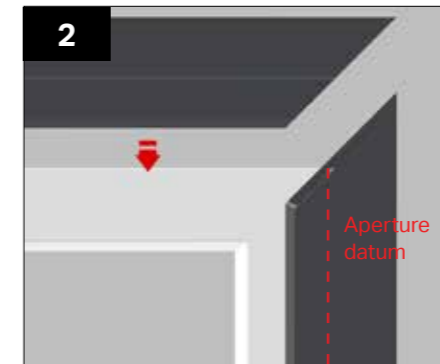

Install the top trim. The corners are pre-mitred to fit together.



Install the top rails according to the location plan. A fixing should be placed at each intersection where the rail crosses a clip. The top of the top rails should be flush against the eaves.

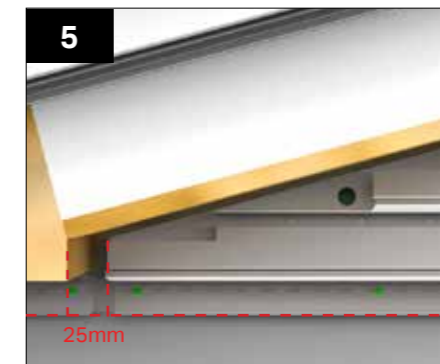

If specified, install the raked panels. Align the "hanger rail" part of the panel with the already installed top rail and set the panel 20-25mm back from the back of the beam. Fix in each fixing hole provided along the raked edge, and with 1 fixing along the horizontal rail in each intersection with a clip

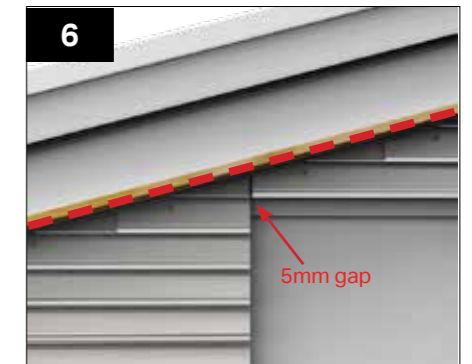

Where there are multiple raked panels along the wall, align the top of the panels and allow a 5mm between the panels.

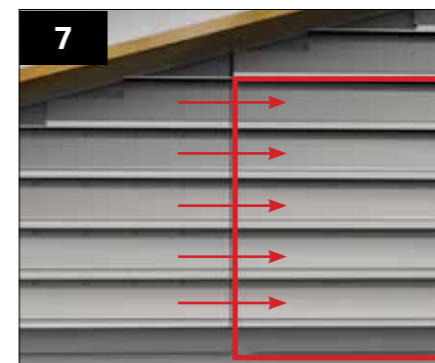

To check the correct positioning, hang the next panel down in place and check alignment of the courses. If the courses do not align, adjust the raked panels accordingly.

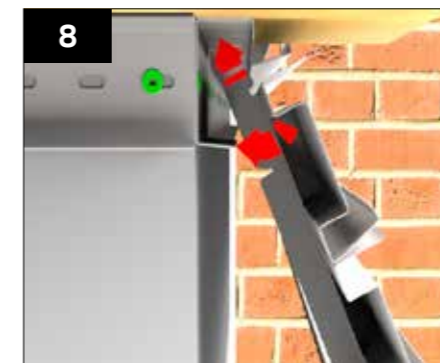

Working from top to bottom, install the panels by hanging each panel from the above panels or top rail.

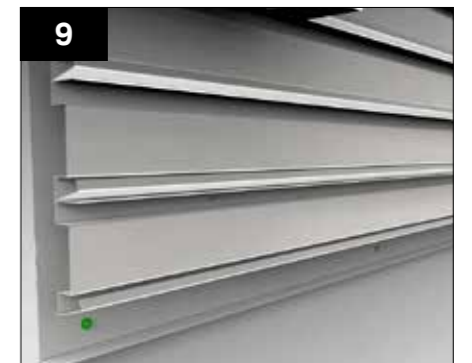

Fix each panel along the bottom rail (which is used to hang the next panel) using 2 GPHS001 fixings at each clip location

Brick Slips Rail Installation

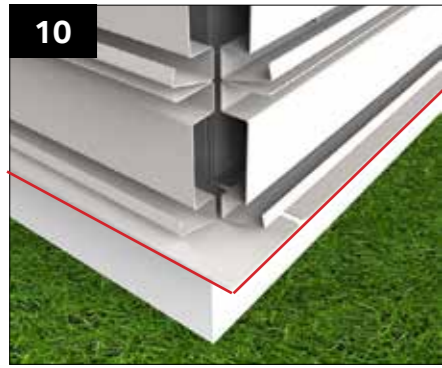

The panels at the bottom of the wall have a different supporting rail than the others – this is to support the application of pointing mortar at the base. Pay attention to the corners, which should overlap as shown.

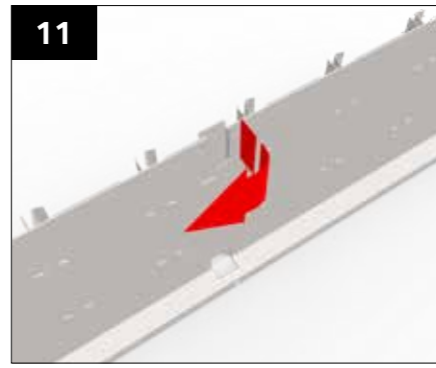

Where soldier course panels are specified, install these by first folding out the hanging tabs by hand 90o to the rear of the panel (warning: fold only once, repeat folding may result in the tab weakening or breaking).

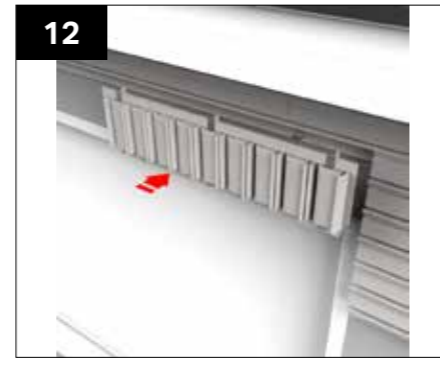

Once all the tabs on the panel are folded, install the panels according to the location plan, fixing at each pre-punched fixing location at the base of the panels. Note that soldier course panels should be the last panels installed.

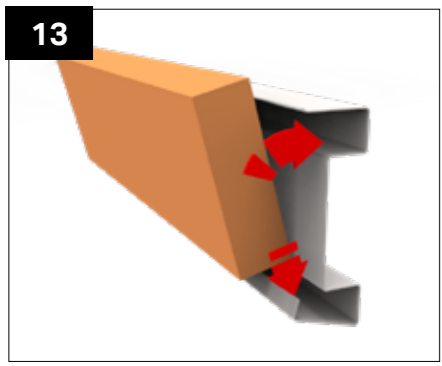

Install the brick slips by pressing down into the tabs and rotating the brick slip into place.



It is recommended to start at the corners, working away from there. Position the corner brick slips in alternating directions for each course.

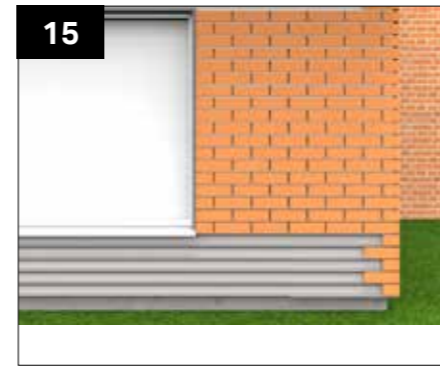

Space the brick slips with a 10mm gap between each slip, ensuring the courses are even and consistent

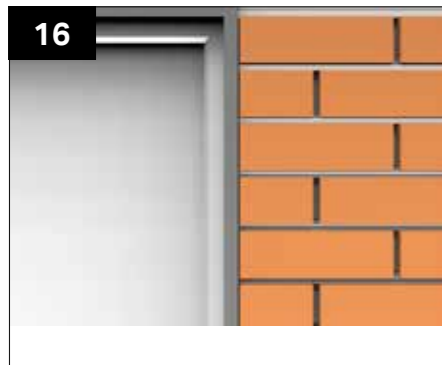

Where aperture trims are specified, the brick course should run up to the trim. If required, cut the brick slips to fit.



Where a brick reveal is specified, use corner brick slips, cutting the return as required to fit to the frame.



For a standard stretcher course, there is no brick return and standard brick slips are used. This could be specified both with and without a side brick reveal.

Brick Slips Rail Installation

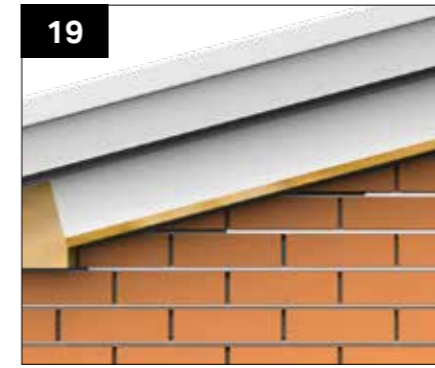

On a raked section of wall, ensure the soffit is fitted before you cut the brick slips at an angle to fit. Maintain alignment with the below courses.

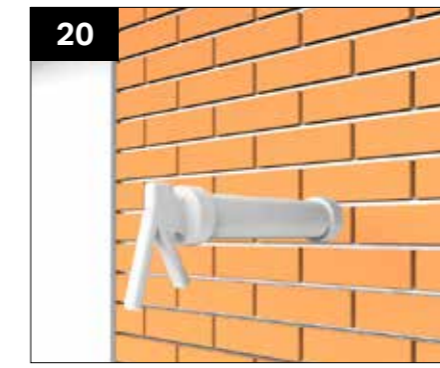

Once the brick slips are fitted, mix the pointing mortar according to the manufacturer's instructions and point between the brick slips using a suitable mortar gun or piping bag.

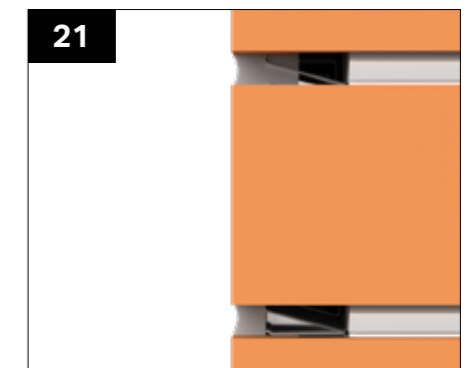

It is essential to ensure that the pointing mortar is applied to the full depth of the brick slip (approximately 20mm) and encapsulates the "tabs" on the brick slip rail. This will ensure a robust mortar line and strong retention of the brick slips.



When the mortar has partially set strike off the mortar lines using a pointing tool to achieve the desired finish (e.g. weather struck, flush, recessed etc.). The time period for striking off varies with different mortars and ambient conditions. Test by gently pressing the mortar line with your finger. If you can leave an imprint on the mortar without any mortar sticking to your finger, it is ready to strike off.



Fit the soffit board and fascia. There are two options:
1. Cut the soffit board so that it runs into the face of the brick slip surface.
2. Run the soffit board over the top of the top brick course

Render Advice

Please pass on this info to the rendering team.

Most renders are appropriate to use with hup! however we recommend a thin coat silicone render, such as Ecorend and K Rend.

If you are choosing to render the walls or require a fire rated board underneath your wall finish, the hup! calcium silicate board can be provided as part of the system. This is pre-cut to size for fast assembly and is A1 fire rated. Remember that cement render is unlikely to work with the hup! aperture trim around apertures as the render will be thicker than the trim. If you use a cement render you will need to provide your own render drip trim suitable for the type of render you require.

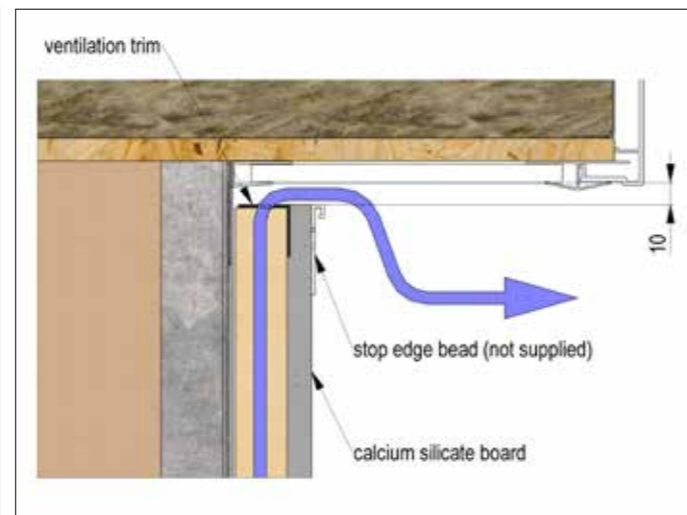
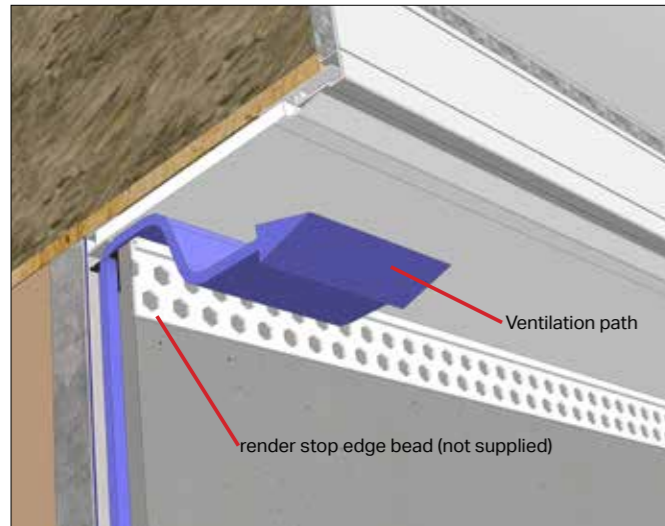

To comply with Building Regulations, a 10mm continuous ventilation gap must be present. The calcium silicate board is supplied and set (by the position shown in the installation guide) to leave this 10mm gap. Please ensure that when rendering or cladding that this 10mm gap is maintained.

A 10mm continuous ventilation gap must be maintained at the top of the hup! wall. If rendering, a suitable stop edge bead must be installed along the top of the calcium silicate board to maintain this gap whilst ensuring a crisp edge on the top of the render.

Top tips for rendering on a hup!



Steel Façade

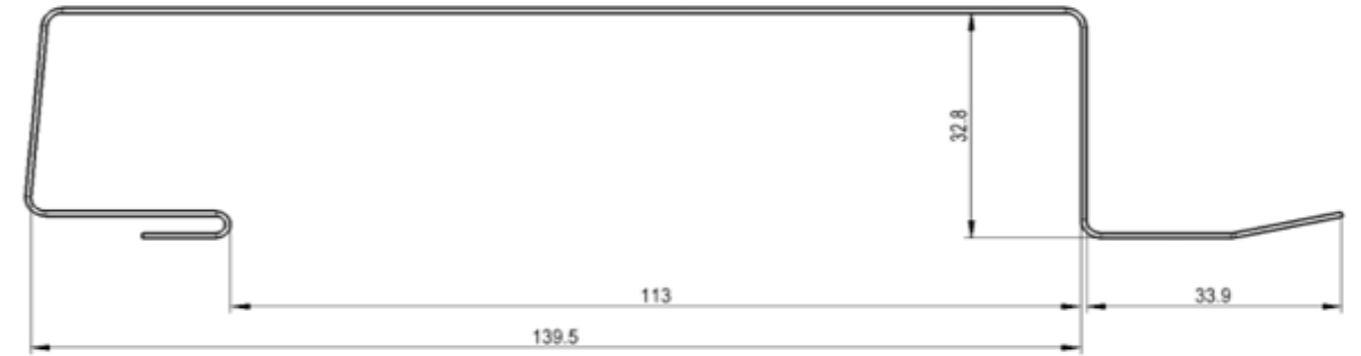

Profile Dimensions:

The main profile (M-17103) detailed below needs to be supported internally when a cut is required. This helps the profile maintain its shape when cutting and provides the best result.

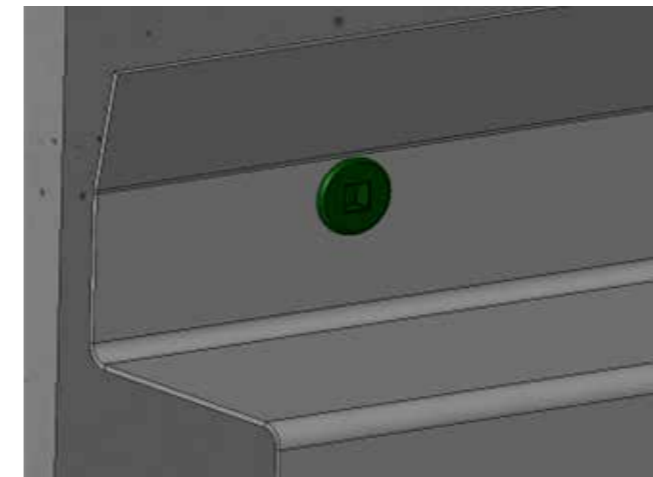

General fixing note:

When fixing the main profile (M-17103) ensure the fixing is positioned just below the angled flange as shown in the image below. This ensures the fixings are hidden once assembled and prevents clashing between profiles.

Skip to step 3 if the build has no inline joint.

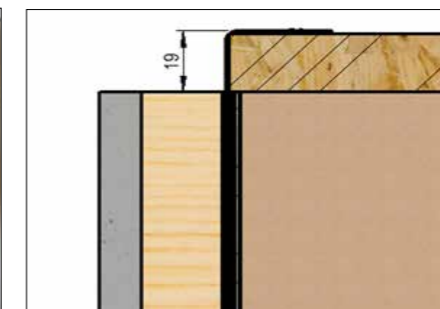

Position 25mm battens against wall clips and fix using HSSCA fixings at 450mm centres. For apertures, the battens are positioned inline with the aperture tray. The 25mm battens start at the base and finish 19mm from the top of the wall.

When an inline joint is required an additional 25mm batten needs to be fixed in the location chosen for the inline joint. Use HSSCA fixings to fit the batten to the top and base tray as well as fixing horizontally into the batten alongside it.

Steel Façade

hup!
The better way to build

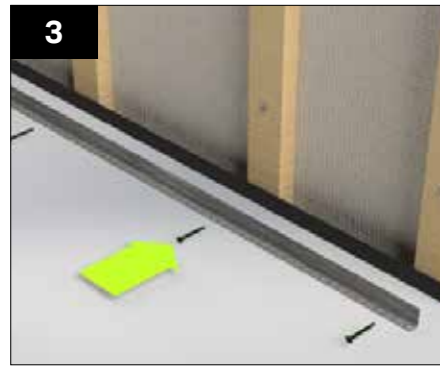

Push the ventilation trim up to the 25mm battens and hold it in place before pushing the CSB starter trim (M-17516) up to it. Fix through the CSB starter trim and ventilation trim into the 25mm battens using GPHS fixings.

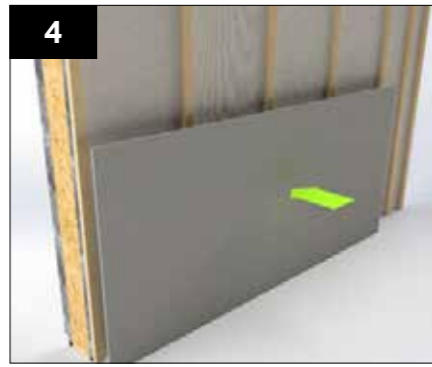

Fix calcium silicate board using GPHS fixings going through into the battens. Ensure the batten positions are marked out on the calcium silicate board to aid when fixing the steel profiles.

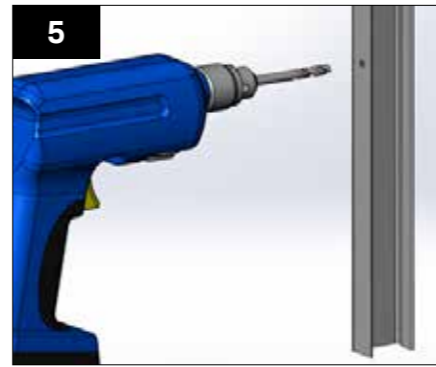

Take the corner profile/inline joint (M-17322) and drill pilot holes through the bottom face. Offset the first pilot 75mm from the bottom, then in increments of 450mm. Ensure the profile is orientated the correct way before drilling, shown in steps 6 & 9.

Skip to step 8 if the build has no inline joint.

Step to step 8 if the build has no inline joint on a raked wall.

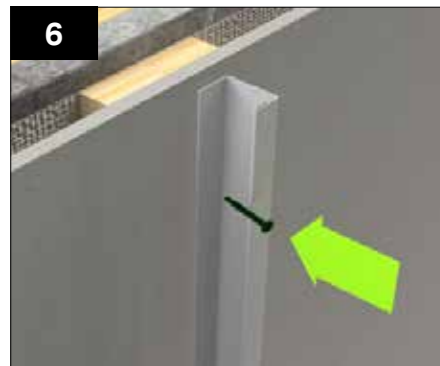

If an inline joint (M-17322) has been specified fix it to the additional 25mm batten fitted previously. Use GPHS fixings at 450mm centres and ensure the first fixing is 75mm from the base. The flat side of the inline joint should always be facing the corner post. For example, in the image shown the corner post is on the right.

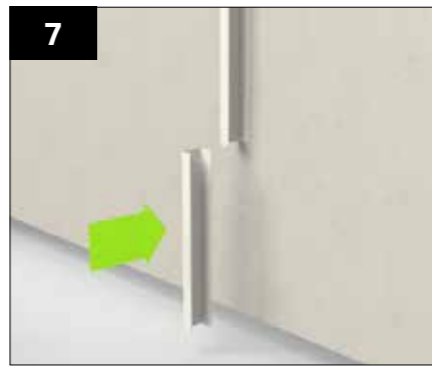

On a raked wall in some scenarios 2 inline joints are required due to the wall height exceeding 3000mm. When this happens fit the first joint to the top of the wall, then cut the second joint down to size and fix at the bottom.

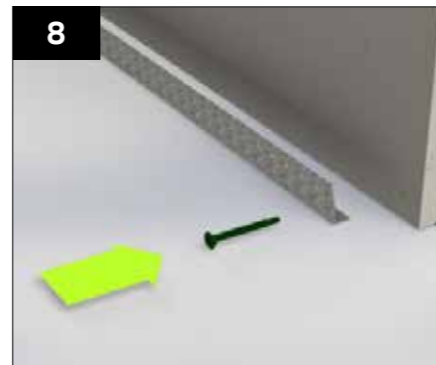

Push starter trim (M-17105) up to the calcium silicate board, it will hook under the bottom of the CSB starter profile (M-17516) to position the height of the profile. Offset the starter trim 25mm from the end of the wall on both sides, a length trim may be required to achieve this. If a trim is required use a grinder or saw to cut the steel profile. Fix profile back using GPHS fixings at every 25mm batten.

Skip to step 11 if the build does not have the host wall trim (M-17118) option.

Skip to step 12 if the wall is raked.



The inline joint / corner trim (M-17322) can be fixed to the end of the wall aligning the outside face with the edge of the calcium silicate board and the 25mm batten. M-17322 fixed back with GPHS fixings at 450mm centres, ensure the first fixing is 75mm from the base.



When the host wall profile (M-17118) option is selected, push M-17118 up to the calcium silicate board up against the host wall. Then fix back using GPHS at 450mm centres, ensure the first fixing is 75mm from base.

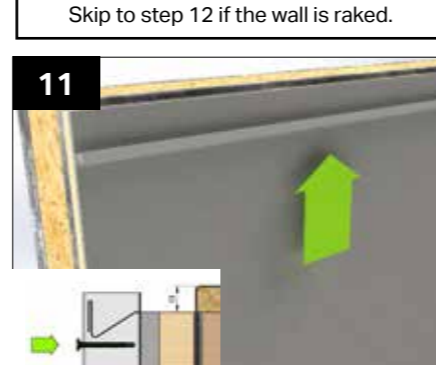

Take the top bracket (M-17147) and align the hem with the top of the calcium silicate board and 25mm battens. Fix the top bracket profile (M-17147) using GPHS fixings on every 25mm batten.

hup!
The better way to build

Skip to step 13 if the build does not have a raked wall.

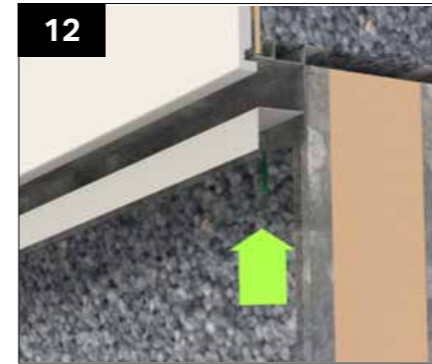

In raked wall situations the finishing trim M-17136 is used to cover the angled cuts on the main profiles. To fit this trim push it up to the Ultrarof gable connection angle (WPCA999/1) and fix with GPHS fixings every 450mm. The profile should be offset by 15mm from the end of the beam.

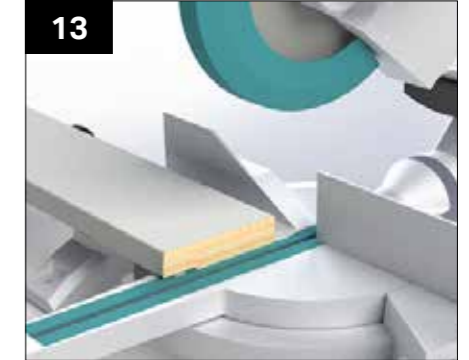
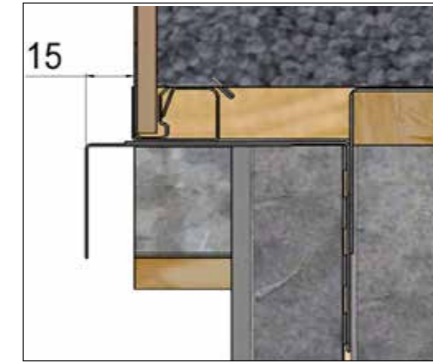

If the main profile (M-17103) requires a cut in length or at an angle for raked walls, use a mitre saw. Ensure the whole profile is level and supported on both ends. For the best result pack-out the inside of the profile with timber blocks and use a blade specific for thin steel. If possible, trim the side which will sit behind the corner or inline trim to hide the cut surface.

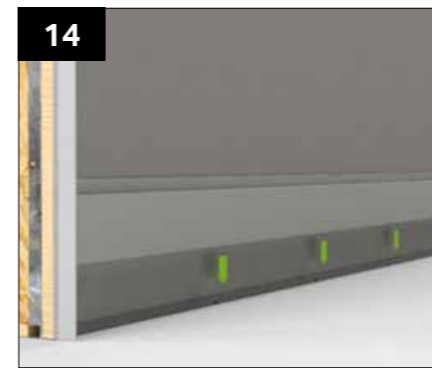

Slot the main profile behind the starter profile, push it up against the wall then drop it down. Ensure the main profile is pushed down so the bottom of the profile is aligned with the bottom of the battens and base tray. To double check the top face of the profile should be 140mm from the battens and base tray.

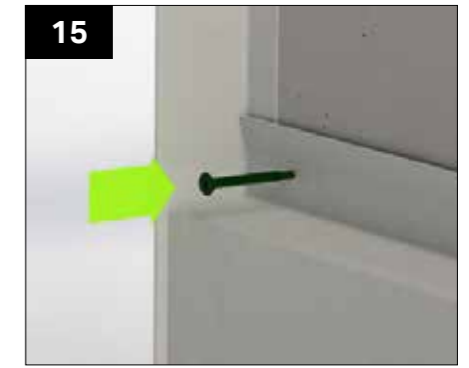

Fix the main profile back into the calcium silicate board and 25mm battens using GPHS fixings at every 25mm batten. Ensure the fixing sits just below the angled flange so the fixings are hidden once assembled.

Skip to step 20 if the build is not raked.



Before fitting the next profile take a 9mm packer and sit it on top of the flat face of the first profile. Then take another profile (M-17103) and push it down over the angled flange up to the 9mm packer. Ensure the whole profile is level then fix back using GPHS fixings on every 25mm batten. To double check the profile's position it should sit 290mm from the battens and base tray, this value will increase by 150mm after each profile.

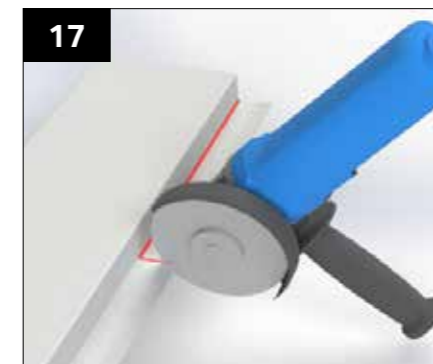

For raked walls a cut is required when fitting the profile directly below the beam. Measure 221mm from the end of the profile and remove the whole upstand from the main profile (M-17103) using a grinder.

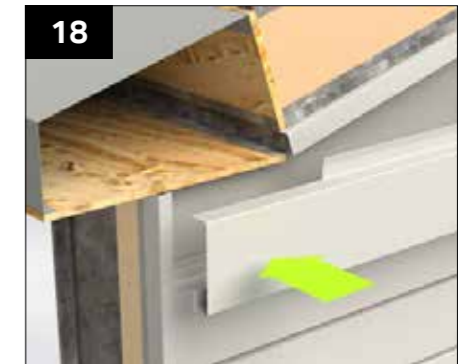

After trimming the main profile (M-17103) it can fit below the beam without intersecting.

Steel Façade



After completing a mitre cut on the main profile (M-17103) slot it behind the finishing profile and fix it back through the CSB into the 25mm battens. The same fixing rules apply for mitred sections.

Skip to step 23 if the build is raked

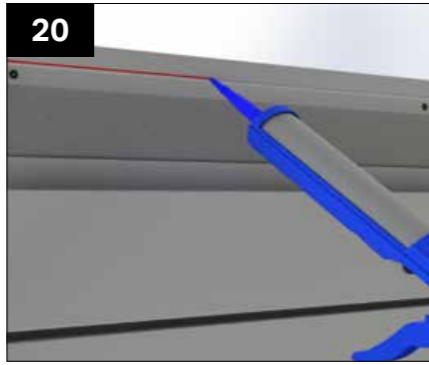

Before fitting the top profile (M-17109) apply sealant to the inside the open hem along the entire length of the top bracket (M-17147).

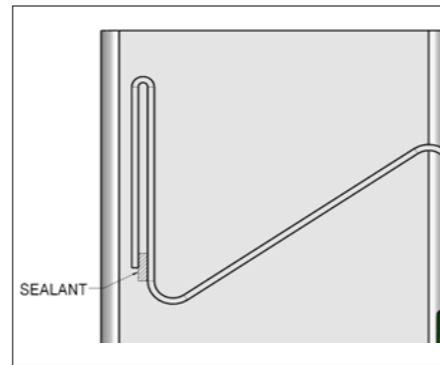

Take the top profile (M-17109) and slot it inside the open hem on the top bracket. Then push the profile up as high as possible before pushing the bottom of the profile into the calcium silicate board. The top profile should then be hooked over the main profile/aperture below.

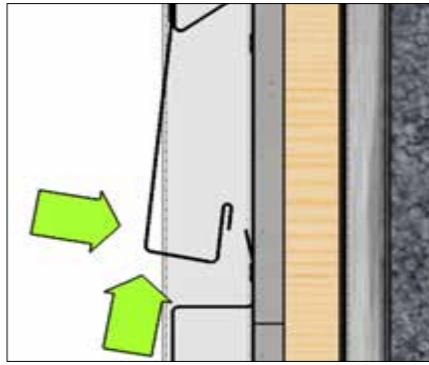

Once hooked over, the top profile can be pulled down. A suction cup or any object that can grab the face of the profile is recommended to help grip the profile.

Skip if the build does not have a raked wall.



In some cases, the final profile on a raked wall will be too small to fix back into the calcium silicate board. In this case use foam tape or another form of packer and stick it on the top profile hiding it behind the finishing trim (M-17136).

Wiring Details

WARNINGS

- ALL WIRING MUST BE CARRIED OUT BY A PART P QUALIFIED ELECTRICIAN TO THE LATEST BS7671 REQUIREMENTS FOR ELECTRICAL INSTALLATIONS!
- If cables need to be run up the wall or around apertures, **THE CABLE MUST BE SHEATHED IN A FLEXIBLE CONDUIT!** This is to avoid contact between the cable and the EPS.

Cable Management Panels

A cable management panel option is available for running cables around the perimeter of the build. It is supplied on every panel if this option is selected:

- The channel is set at 450mm above the DPC level and allows holes to be drilled between panels through the hardboard and cables fed through.
- The channel is deep enough to cater for socket back boxes.



Alternative Methods (Glass and Hybrid Roofs)

If a cable management panel is not specified, the wiring can be run around the perimeter of the eaves and then dropped vertically to the required position of the socket or switch. When running the cable across or down the face of the EPS, **the cable must be run in a flexible conduit.**

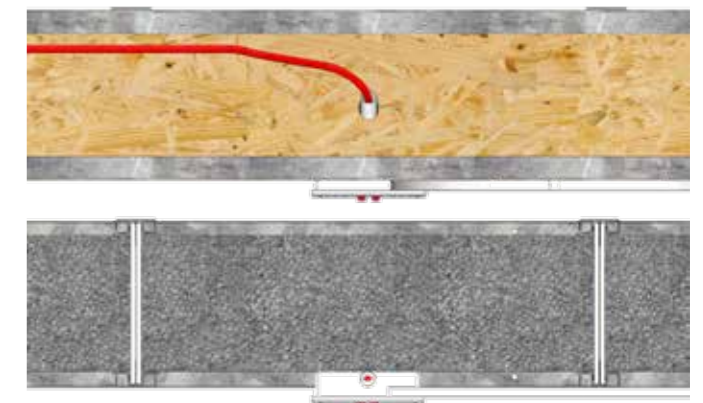
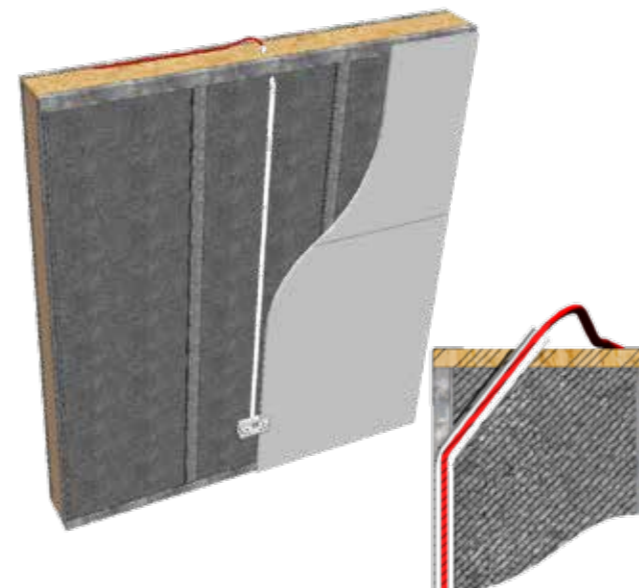

Drill hole through top tray and EPS to thread conduit through.

Wiring Details

Alternative Methods - (Tiled and Flat Roof)

If a cable management panel is not specified, the wiring can be run around the perimeter of the eaves and then dropped vertically to the required position of the socket or switch. When running the cable across or down the face of the EPS, **the cable must be run in a flexible conduit.**



Option 1

Drill a 20mm diameter hole either side of the clip into the back of the beam. Push in a grommet to protect the cable against the steel edge. Using a rigid wire pull string through the holes to enable feeding cable through.

Option 2

Drill an angled 20mm diameter hole (shown in red) either side of the clip into the EPS and break through the hardboard behind the steel clip. Using a rigid wire pull string through the holes to enable feeding cable through. **Ensure that cable is in conduit to isolate from the EPS.**

Cable Management Panel

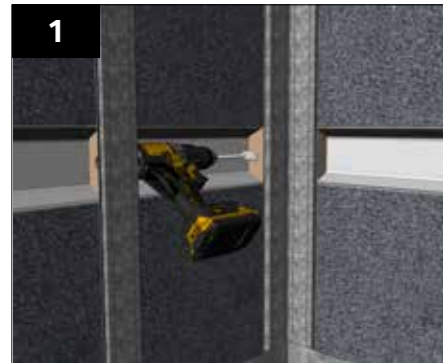

Using a hole saw or spade bit, drill holes through the hardboard sides of the panel within the cable management channel. Repeat into the corner to take cabling around the corner.

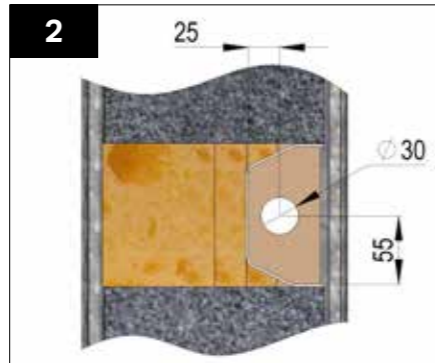

Position hole approximately central to the cable management channel and around 30mm in diameter but no larger than 38mm.

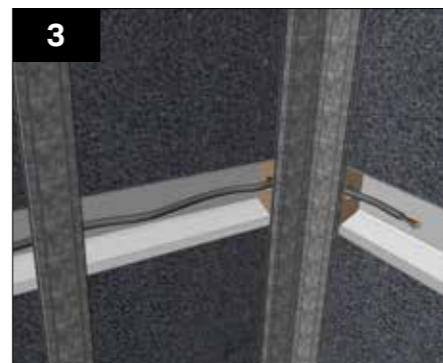

Run cable through the drilled holes. If cable needs to run vertically up the wall from the cable management channel, run this cable in conduit.



Cutaway section of corner showing void for cable to run through corner to the adjacent wall. Note earth-wool will be within the void, but this can easily be pushed out of the way.

Hanging objects from interior walls

The hup! wall are strong enough to hold heavy objects e.g. kitchen cupboards, however it is about the retention of the fixings into the plasterboard. There are a few options when fixing heavy objects to hup! walls.

1. Line the inside of the walls with plywood/OSB along the area where the units are to be fitted and then plasterboard over.
2. There are many plasterboard fixings that are capable of supporting large loads (data sheets indicated products tested on 15mm plasterboard as specified on hup! walls), however most of these products expand behind the plasterboard and dependant on the proximity of the steel clips on the walls in relation to the fixing position on the unit, could prevent the fixing from expanding. Therefore, we advise that you determine where the steel studs are beforehand either using the build location plan or a stud finder.
3. The other option is to fit a timber batten across the wall behind the units fixing directly into the steel clips and then using this to fix the units into. The steel clips can be found with a stud finder or by tapping the board to find the hollow spots. Alternatively, if the plasterboard is not fitted, whilst installing, mark the position of the steel clips on the board.



Installation Guide

Version 14 | 01.26

JN: 9056 | PC: HUG001

hup! - A Building Revolution from Ultraframe

hup![®]
The better way to build